



ORION 46

Series 8920

GAS-FIRED DIRECT-VENT HEATER
OEM Model# SL-46N & SL-46P

Owner's Manual Installation & Operating Instructions

Read This Manual in Its Entirety
Operate and Maintain This Gas Heater
According to This Instruction Manual.



SAVE THESE INSTRUCTIONS



WARNING:

FIRE OR EXPLOSION HAZARD

Failure to follow safety warnings exactly could result in serious injury, death, or property damage.

-  Do not store or use gasoline or other flammable vapors and liquids in the vicinity of this or any other appliance.
-  **WHAT TO DO IF YOU SMELL GAS:**
 - Do not try to light any appliance.
 - Do not touch any electrical switch; do not use any phone in your building.
 - Leave the building immediately.
 - Immediately call your gas supplier from a neighbor's phone. Follow the gas supplier's instructions.
 - If you cannot reach your gas supplier, call the fire department or 911.
-  A qualified installer, service agency, or gas supplier must perform installation and service of this appliance. In the Commonwealth of Massachusetts, all installation of gas lines and gas fittings must be performed by a licensed gas fitter or licensed plumber.

DANGER



HOT GLASS WILL CAUSE BURNS.

DO NOT TOUCH GLASS UNTIL COOLED.

NEVER ALLOW CHILDREN TO TOUCH GLASS.

A barrier designed to reduce the risk of burns from the hot viewing glass is provided with this appliance and shall be installed for the protection of children and other at-risk individuals.

California Prop 65

 **WARNING:** This product can expose you to chemicals including glass wool fiber and carbon monoxide which are known to the State of California to cause cancer, birth defects or other reproductive harm. For more information go to www.P65Warnings.ca.gov

Ce manuel est disponible en Francais a
www.hearthstonetech.com

POËLE AU GAZ À VENTILATION DIRECTE



Manuel de l'Utilisateur Lire ce Manuel en Entier

Utiliser et Entretienir ce Poêle au Gaz
selon ce Manuel d'Instructions

CONSERVER CES INSTRUCTIONS!

AVERTISSEMENT:

RISQUE D'INCENDIE OU D'EXPLOSION
Le non-respect des avertissements de sécurité
serait exactement entraîner des blessures graves,
la mort ou des dommages matériels.

-  Ne pas entresposer ni utiliser d'essence ni d'autre vaperurs ou liquides inflammables dans le voisinage de cet appareil ou de tout autre appareil.
-  **QUE FAIRE SI VOUS SENTEZ UNE ODEUR DE GAZ:**
 - Ne pas tenter d'allumer d'appareil.
 - Ne touchez à aucun interrupteur. Ne pas vous servir des téléphones se trouvant dans le bâtiment où vous vous trouvez.
 - Quittez le bâtiment immédiatement.
 - Appelez immédiatement votre fournisseur de gaz depuis un voisin. Suivez les instructions du fournisseur.
 - Si vous ne pouvez rejoindre le fournisseur de gaz, appelez le service des incendies
-  L'installation et l'entretien doivent être assurés par un installateur ou un service d'entretien qualifié ou par le fournisseur de gaz.

 **DANGER**



UNE VITRE CHAUDE PEUT CAUSER DES BRÛLURES.

NE PAS TOUCHER UNE VITRE AVANT QU'ELLE NE REFROIDISSE.

NE JAMAIS LAISSER UN ENFANT TOUCHER À LA VITRE.

Une barrière de sécurité est recommandée pour réduire les risques de brûlures causées par la vitre chaude de cet appareil et doit être installée pour la protection des enfants et d'autres personnes à risque.

INDEX

IMPORTANT SAFETY INFORMATION.....	4
SPECIFICATIONS.....	5
INSTALLATION REQUIREMENTS.....	6
MASSACHUSETTS REQUIREMENTS.....	7
VENTING.....	8
ASSEMBLY & INSTALLATION.....	16
Fuel Conversion.....	26
GAS CONNECTION.....	19 & 29
LIGHTING AND OPERATION.....	36
MAXITROL CONTROL SYSTEM.....	38
MAINTENANCE.....	44
MAINTENANCE LOG FORMS.....	47
INSTALLATION RECORD.....	48
REPLACEMENT PARTS LIST.....	49
CONTROL SCHEMATIC.....	50
TROUBLESHOOTING.....	51
WARRANTY INFORMATION.....	53

WE STRONGLY SUGGEST THAT YOU READ THIS MANUAL THOROUGHLY BEFORE BEGINNING THE INSTALLATION OF THE ORION 46 DIRECT VENT GAS FIREPLACE. ALTHOUGH THE BASIC REQUIREMENTS FOR THE INSTALLATION OF ALL DIRECT VENT GAS FIREPLACES ARE SIMILAR, EACH SPECIFIC PRODUCT HAS ITS OWN UNIQUE SET-UP AND INSTALLATION REQUIREMENTS THAT MUST BE FOLLOWED EXACTLY. PLAN YOUR INSTALLATION IN ADVANCE BY CAREFULLY REVIEWING ALL THE INFORMATION CONTAINED IN THIS MANUAL.

Important Safety Information

The installation must conform with local codes or, in the absence of local codes, with the *National Fuel Gas Code, ANSI Z223.1/NFPA 54*, or the *Natural Gas and Propane Installation Code, CSA B149.1*.

A manufactured home (USA only) or mobile home OEM installation must conform with the *Manufactured Home Construction and Safety Standard, Title 24 CFR, Part 3280* or when such a standard is not applicable, the *Standard for Manufactured Home Installations, ANSI/BCSBCS A225.1*, or *Standard for Gas Equipped Recreational Vehicles and Mobile Housing, CSA Z240.4*.

The appliance and its appliance main gas valve must be disconnected from the gas supply piping system during any pressure testing of that system at test pressures in excess of 1/2 psi (3.5 kPa).

The appliance must be isolated from the gas supply piping system by closing its equipment shutoff valve during any pressure testing of the gas supply piping system at test pressures equal to or less than 1/2 psi (3.5 kPa).

The installation must provide for adequate ventilation air to the appliance.

This gas appliance must not be connected to a chimney flue serving a separate solid-fuel burning appliance.

The appliance, when installed, must be electrically grounded in accordance with local codes, or, in the absence of local codes, with the *National Electrical Code ANSI/NFPA 70*, or the *Canadian Electrical Code, CSA C22.1*.

The appliance area must be kept clear and free from combustible materials, gasoline and other flammable vapors and liquids.

The flow of combustion and ventilation air must not be obstructed.

Do not use this appliance if any part has been under water. Immediately call a qualified service technician to inspect the appliance and to replace any part of the control system and any gas control which has been under water.

Due to high temperatures, the appliance should be located out of traffic and away from furniture and draperies. Installation of a TV or, any other electrical appliance, above this fireplace is not allowed.

Children and adults should be alerted to the hazards of high surface temperatures and should stay away to avoid burns or clothing ignition.

Young children should be carefully supervised when they are in the same room as the appliance. Toddlers, young children and others may be susceptible to accidental contact burns. A physical barrier is recommended if there are at-risk individuals in the house. To restrict access to a fireplace or a stove, install an adjustable safety gate to keep toddlers, young children and other at-risk individuals out of the room and away from hot surfaces.

A barrier designed to reduce the risk of burns from the hot viewing glass is provided with this appliance and shall be installed for the protection of children and other at-risk individuals.

If the barrier becomes damaged, the barrier shall be replaced with the manufacturer's barrier for this appliance.

Clothing or other flammable material should not be placed on or near the appliance.

Any screen or guard removed for servicing an appliance must be replaced prior to operating the appliance.

Installation and repair should be done by a qualified service person. The appliance should be inspected before use and at least annually by a professional service person. More frequent cleaning may be required due to excessive lint from carpeting, bedding material, etc. It is imperative that the control compartments, burners and circulating air passageways of the appliance be kept clean.

WARNING: Do not operate the appliance with the glass front removed, cracked or broken. Replacement of the glass should be done by a licensed or qualified service person.

WARNING: Use only glass assembly, pt# 99-58205 which includes the glass panel, frame and gasket.

Specifications

Testing Agency: OMNI- Test Laboratories, Inc.
PO Box 301367
Portland, OR 97294

Listed: Direct Vent Gas Heater

Model: ORION 46 - 8920

Tested to: ANSI Z21.88b – 2014/CSA 2.33b - 2014

Certified for Canada, CSA P.4.1

Approved for Mobile Home Installation

Certified for use by:

Board of State Examiners of Plumbers and Gasfitters
100 Cambridge Street, Room 1511
Boston, Massachusetts 02202

Manufactured and Warranted by:

Hearthstone Quality Home Heating Products, Inc.
317 Stafford Ave.
Morrisville, VT 05661-8695, USA
www.hearthstonestoves.com

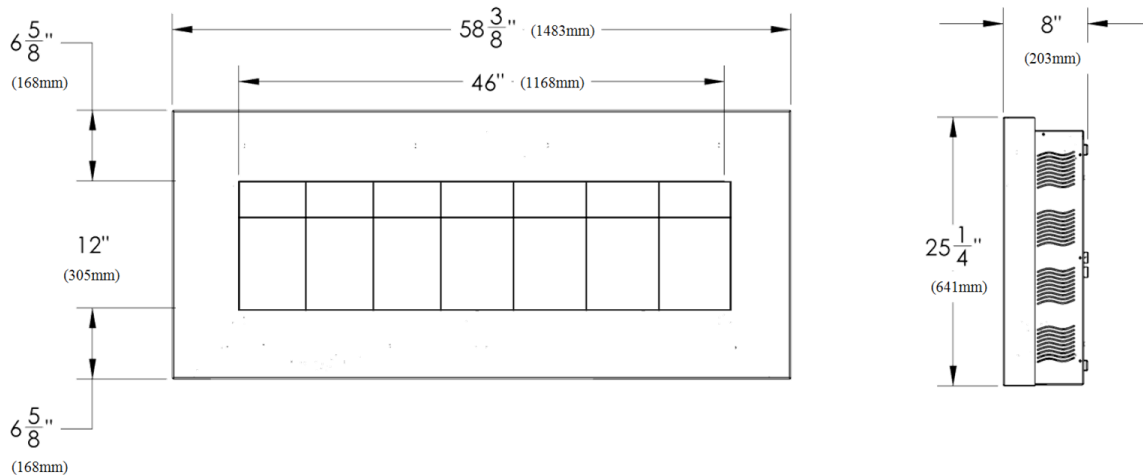

ORION 46 Dimensions

Specification	NG	LP
Input rating (Btu/hr)	29,000	29,000
Orifice size DMS 0-2000 ft	42	53
Manifold pressure (in.w.c./kPa)	3.9/1.0	10.0/2.5
Minimum Supply Pressure (in.w.c./kPa)	5.5/1.4	11.0/2.8
Maximum Supply Pressure (in.w.c./kPa)	10.0/2.5	13.0/3.3
Minimum Inlet press.(in.w.c./kPa)	5.0/1.25	12.0/2.99
Minimum input rating (Btu/hr)	19,000	19,000
Maximum Observed Steady State Efficiency (%)	78.5	79.0
Steady State Efficiency (%)	68.5	69.5
Annual Fuel Utilization Efficiency (AFUE) (%)	69.5	68.9
Canadian P4 Efficiency (%)	56.4	58.8

It is recommended that the pilot flame be turned off if the appliance will not be in use for an extended period of time.

This appliance is equipped for use with the fuel type indicated on the rating plate.

This appliance has been certified by OMNI-Test Laboratories, Inc. to ANSI Z21.88-2014/CSA 2.33-2014. Vented Gas Fireplace Heaters and CAN/CGA-2.17-M91, Gas-Fired Appliances for Use At High Altitudes.

The ORION 46 is approved for installation at elevations up to 2000 feet in the U.S. and 1370 meters (4500 feet) in Canada without change. If your installation is at an elevation greater than these, consult with the local authority having jurisdiction for gas product installations to determine their specific requirements for high altitude installations.

Installation Requirements

Several issues must be addressed when selecting a suitable location for your ORION 46 fireplace. The minimum clearances to combustible construction are listed below. In addition, access to the gas supply must be considered. The location of the fireplace will also affect the venting requirements and you must be certain the location will allow compliance with the venting requirements shown on pages 8-9. You must also insure that your installation provides adequate accessibility clearance for servicing and proper operation.

Installation and repair should be done by a qualified service person. The appliance should be inspected before use and at least annually by a professional service person. More frequent cleaning may be required due to excessive lint from carpeting, bedding material, etc. It is imperative that the control compartment, burners and circulating air passageways of the appliance be kept clean.

MINIMUM CLEARANCES TO COMBUSTIBLE CONSTRUCTION

Fireplace to L. Side Wall	6" (152mm)	Fireplace to Ceiling	8" (203mm)
Fireplace to R. Side Wall	6" (152mm)	Fireplace to Rear Wall	0" (0mm)*
Fireplace to Corner Wall	6" (152mm)	Fireplace to Floor	3" (76mm)**
Vent Pipe to Adjacent Materials	1.5" (38mm)		

*Mounting plate bosses contact the wall

**The minimum required clearance to be maintained from the fireplace to combustible flooring is measured from the top surface of carpeting, tile, etc.

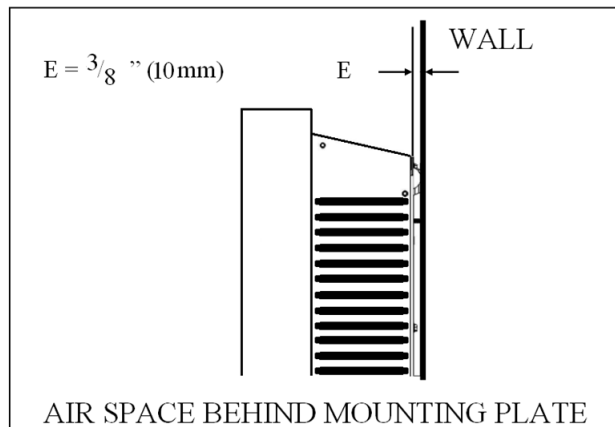
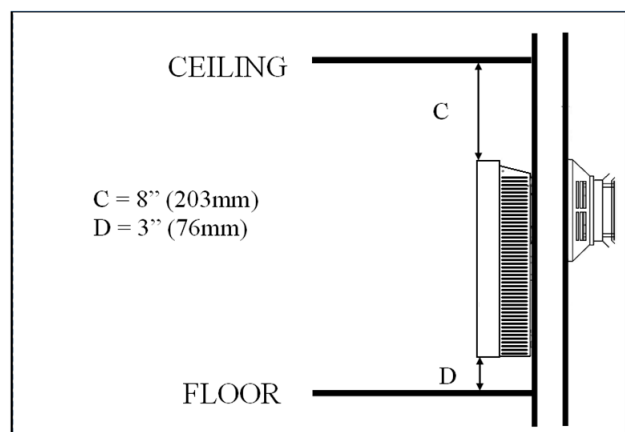
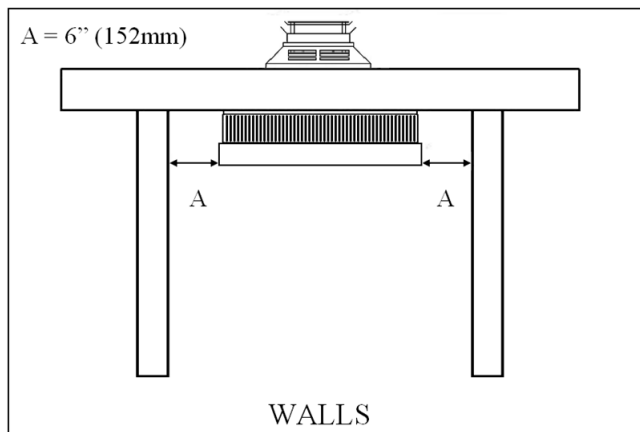

The gas fireplace is shipped with a 3/8" tube OD (male) connection. The gas supply piping should have a separate gas shutoff valve and a 1/8" NPT plugged tapping upstream of the valve. The stove and its main control valve must be disconnected from the gas supply piping system during any pressure testing of that system at test pressures in excess of 1/2 psi (3.5 kPa). The stove must be isolated from the gas supply piping system by closing the main control valve during any pressure testing of the gas supply system at test pressures equal to or greater than 1/2 psi (3.5 kPa). After the gas supply has been connected, use a commercial gas leak detector or apply a soapy water solution to all the fittings to check for gas leaks. Never use a flame to test for leaks.

REQUIREMENTS FOR THE COMMONWEALTH OF MASSACHUSETTS

This product must be installed by a licensed plumber or gas fitter when installed within the Commonwealth of Massachusetts. If this appliance is installed in a dwelling, building or structure used in whole or in part for residential purposes and the installation includes a horizontal vent termination that is less than seven (7) feet above the finished grade in the area of the venting, including but not limited to decks and porches, a hard-wired carbon monoxide detector with an alarm and battery back-up must be installed on the floor level of the dwelling, building or structure where the appliance is to be installed.

Additionally, a hard-wired or battery operated carbon monoxide detector with an alarm must be installed on each additional level of the dwelling, building or structure served by the appliance. It shall be the responsibility of the property owner to secure the services of qualified licensed professionals for the installation of hard-wired carbon monoxide detectors.

In the event that the horizontally vented appliance is installed in a crawl space or attic, the hardwired carbon monoxide detector with alarm and battery back-up may be installed on the next adjacent floor level.

In the event that this requirement cannot be met at the time of completion of the installation of the appliance, the owner shall have a period of thirty (30) days to comply with the requirement. However, during said thirty (30) day period, a battery operated carbon monoxide detector with alarm must be installed.

Each carbon monoxide detector as required in accordance with the above provisions must comply with NFPA 720 and be ANSI/UL 2034 and IAS certified.

In addition when the vent termination is less than seven (7) feet above finished grade a metal or plastic identification plate must be permanently mounted to the exterior of the building at a minimum height of eight (8) feet above grade directly in line with the exhaust vent terminal. The sign shall read, in print size no less than one-half (1/2) inch in size, "GAS VENT DIRECTLY BELOW. KEEP CLEAR OF ALL OBSTRUCTIONS".

A COPY OF THESE INSTRUCTIONS PLUS ALL VENTING INSTRUCTIONS WHICH INCLUDE PARTS LISTS, AND/OR ALL VENTING DESIGN INSTRUCTIONS MUST REMAIN WITH THE STOVE AT THE COMPLETION OF THE INSTALLATION.

ATTENTION INSTALLERS: Mark below which venting system was used in the installation. These instructions must remain with the Orion Installation & Operation Manual.

- | | | |
|---|---|--|
| <input type="checkbox"/> Simpson DuraVent GS/PRO® | <input type="checkbox"/> Selkirk Direct-Temp® | <input type="checkbox"/> Security Secure Vent™ |
| <input type="checkbox"/> AmeriVent Direct™ | <input type="checkbox"/> Metal Fab Direct | <input type="checkbox"/> ICC Direct Vent |

The ORION 46 Direct Vent Gas Fireplace has been tested and listed for installation with 5" X 8" Simpson DuraVent GS/Pro®, Selkirk Direct-Temp®, Security Secure Vent™, AmeriVent Direct™, Metal Fab Direct Vent and ICC EXCELDirect venting components. Although you may use the pipe components (straight pipe, elbows, etc.) from any of the listed manufacturers, you may only use the vent terminations (caps) listed in the chart on page 9. For installations where a snorkel is needed, please note that only three snorkels are approved for use. Please plan your installation accordingly.

For all specific venting installation requirements, follow the installation instructions included by the venting manufacturer with the venting system components you have chosen.

Please note:

- For venting configurations that include no vertical rise, a total horizontal vent run of up to 30 inches (and including one 45° elbow) is allowed. However, if your installation has room to add a vertical pipe section, we suggest adding at least one foot of vertical rise to the system.
- For venting configurations that include vertical rise, it is assumed that the installation will include at least one 90° elbow. Up to three additional 90° elbows (or equivalent 45° elbows) may also be used. The total venting may not exceed 20 feet of vertical rise and/or 10 feet horizontal run. Refer to the venting charts starting on pages 10 & 11 for specific details while you plan your installation. Note: The number of elbows impacts the maximum allowable horizontal vent run.
- Many installations will involve venting directly through standard 2 X 4 or 2 X 6 construction exterior wall to a horizontal vent termination (cap). The vent starter pipe has been designed to accommodate those two common installations without the use of any additional venting components other than a standard horizontal cap. See the chart on page 9 for a list of approved vent caps.
- If the fireplace will be installed on an interior wall or other location that precludes venting directly through an outside wall to a horizontal vent cap, or if the distance to the outside wall exceeds 30", one or more elbows will be required to allow addition of the required vertical venting to the installation. When vertical venting is required, the fireplace venting may be terminated with either a vertical or horizontal vent cap depending on the specifics of the installation. Refer to the venting charts starting on pages 10 & 11 for specific venting requirements and see the chart on page 9 for a list of approved vent caps before you plan your installation.
- There should be a 1 1/2" overlap of the vent and combustion air tubes, when telescopic joints are used.
- A minimum clear space of 1 1/2" must be maintained around the vent pipe where it penetrates the first combustible wall adjacent to the fireplace (either the outside wall for the direct-through-the-wall installation or the partition wall for the 45° or other interior wall installations). The special vent pipe heat shields that are provided with the ORION 46 must also be installed in the first wall adjacent to the fireplace. A minimum clear space of 1 1/2" must also be maintained where the vent pipe penetrates any other interior wall, exterior wall, ceiling or roof.
- There should be a 1 1/2" minimum overlap of the vent and combustion air tubes, when telescopic joints are used.

Using Vent Charts

- The location of the vent termination must meet the requirements of the current edition of ANSI Z223.1/NFPA 54, National Fuel Gas Code or CAN B419.1, Natural Gas and Propane Installation Code and the requirements shown on page 15 of this manual.

<u>APPROVED VENT TERMINATIONS</u>	<u>DURAVENT GS/PRO</u>	<u>SELKIRK DIRECT-TEMP</u>	<u>ICC EXCEL DIRECT</u>
<u>VERTICAL CAP</u>	58 DVA-VC Low Profile Cap	None Approved	TM5VT 5 X 8 Vert. Cap
<u>HORIZONTAL CAP</u>	58 DVAHC	None Approved	None Approved
<u>SNORKEL</u>	58DVASNK14 – 14” Snorkel 58DVASNK36 – 36” Snorkel	5DT-ST14 – 14” Snorkel	None Approved

Just as with any other vented device, vertical vent rise creates draft (negative pressure) in the firebox as the exhaust gases heat up. If this draft becomes excessive, it can affect the performance or appearance of the fire. The ORION 46 fireplace includes air and exhaust restrictors that are used to balance the draft in the fireplace to the optimal level for installations where excessive draft might occur. The venting charts on pages 10 and 11 provide an easy means for determining whether your specific installation requires inlet air or exhaust restrictors or both. To make the determination about whether air or exhaust restrictors are needed, a venting chart worksheet is provided on page 12. Follow the instructions and fill in the worksheet for your particular installation. This will allow you to determine the recommended restrictor settings for your exact installation. Although this might appear to be a complicated process at first glance, it is really quite straight-forward and the result will be a fire that looks and performs as intended. Several examples of worksheet calculations are shown on page 13 to help guide you.

Please be sure to note that:

1. There are separate venting charts for Natural Gas and LP Gas. Refer to the appropriate chart for your fuel type to determine your specific restrictor requirements. The settings in the charts have been determined based on extensive testing.
2. Determine the total vertical vent rise and total horizontal vent run for your installation. All measurements are made from the center of the vent opening in the back of the fireplace.
3. If your fireplace will not be venting directly through an outside wall to a horizontal termination or if more than 30” of horizontal vent run is required, some vertical vent rise will be required for the fireplace to function and vent properly. Elbows will also be required for those installations. However, installations are limited to a maximum of four 90° elbows (or 45° elbow equivalents).
4. Note: Two 45° elbows equal one 90° elbow.
5. The recommended restrictor settings in the venting charts allow up to two 90° elbows (or 45° elbow equivalents) to be used without affecting the restrictor settings. Additional elbows will require that you calculate a new equivalent horizontal run for your installation to account for the additional flow resistance caused by the extra elbows. For the purposes of calculating the equivalent horizontal vent run, each additional 90° elbow is equivalent to three feet of horizontal vent run. The total horizontal vent run including elbow equivalents cannot exceed 10 feet.
6. The maximum vertical vent rise cannot exceed 20 feet.
7. There are two exhaust restrictors that are provided with your ORION 46 fireplace. They are labeled “C” and “D”. The “C” restrictor provides less exhaust restriction than “D”.
8. An air restrictor plate is also provided with your fireplace. It is a ring with bendable tabs that can be set to adjust the amount of restriction in the air supply system. Once the appropriate number tabs are bent open (in accordance with the requirements for your installation), the plate is inserted between the fireplace and the vent starter pipe.

Natural Gas Venting Chart

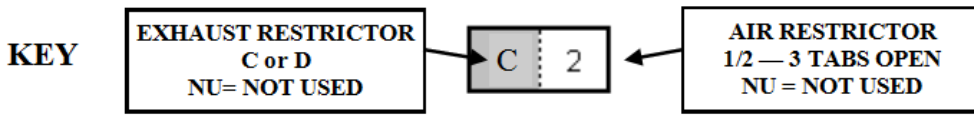

VERTICAL RISE IN FEET

	0	1	2	3	4	5	6	7	8	9	10	
30	D 1/2	X X	X X	X X	X X	X X	X X	X X	X X	X X	X X	30
29	D 1/2	D 1/2	X X	X X	X X	X X	X X	X X	X X	X X	X X	29
28	D 1/2	D 1/2	D 1/2	X X	X X	X X	X X	X X	X X	X X	X X	28
27	D 1/2	D 1/2	D 1/2	D 1/2	X X	X X	X X	X X	X X	X X	X X	27
26	D 1	D 1	D 1	D 1	D 1	D 1	X X	X X	X X	X X	X X	26
25	D 1	D 1	D 1	D 1	D 1	D 1	D 1	X X	X X	X X	X X	25
24	D 1	D 1	D 1	D 1	D 1	D 1	D 1	D 1	X X	X X	X X	24
23	D 1 1/2	D 1 1/2	D 1 1/2	D 1 1/2	D 1 1/2	D 1 1/2	D 1 1/2	D 1 1/2	D 1 1/2	X X	X X	23
22	D 1 1/2	D 1 1/2	D 1 1/2	D 1 1/2	D 1 1/2	D 1 1/2	D 1 1/2	D 1 1/2	D 1 1/2	D 1 1/2	X X	22
21	D 1 1/2	D 1 1/2	D 1 1/2	D 1 1/2	D 1 1/2	D 1 1/2	D 1 1/2	D 1 1/2	D 1 1/2	D 1 1/2	D 1 1/2	21
20	D 1 1/2	D 1 1/2	D 1 1/2	D 1 1/2	D 1 1/2	D 1 1/2	D 1 1/2	D 1 1/2	D 1 1/2	D 1 1/2	D 1 1/2	20
19	D 1 1/2	D 1 1/2	D 1 1/2	D 1 1/2	D 1 1/2	D 1 1/2	D 1 1/2	D 1 1/2	D 1 1/2	D 1 1/2	D 1 1/2	19
18	D 1 1/2	D 1 1/2	D 1 1/2	D 1 1/2	D 1 1/2	D 1 1/2	D 1 1/2	D 1 1/2	D 1 1/2	D 1 1/2	D 1 1/2	18
17	D 1 1/2	D 1 1/2	D 1 1/2	D 1 1/2	D 1 1/2	D 1 1/2	D 1 1/2	D 1 1/2	D 1 1/2	D 1 1/2	D 1 1/2	17
16	D 1 1/2	D 1 1/2	D 1 1/2	D 1 1/2	D 1 1/2	D 1 1/2	D 1 1/2	D 1 1/2	D 1 1/2	D 1 1/2	D 1 1/2	16
15	D 1 1/2	D 1 1/2	D 1 1/2	D 1 1/2	D 1 1/2	D 1 1/2	D 1 1/2	D 1 1/2	D 1 1/2	D 1 1/2	D 1 1/2	15
14	D 1 1/2	D 1 1/2	D 1 1/2	D 1 1/2	D 1 1/2	D 1 1/2	D 1 1/2	D 1 1/2	D 1 1/2	D 1 1/2	D 1 1/2	14
13	D 1 1/2	D 1 1/2	D 1 1/2	D 1 1/2	D 1 1/2	D 1 1/2	D 1 1/2	D 1 1/2	D 1 1/2	D 1 1/2	D 1 1/2	13
12	D 2	D 2	D 2	D 2	D 2	D 2	D 2	D 2	D 2	D 2	D 2	12
11	D 2	D 2	D 2	D 2	D 2	D 2	D 2	D 2	D 2	D 2	D 2	11
10	D 2 1/2	D 2 1/2	D 2 1/2	D 2 1/2	D 2 1/2	D 2 1/2	D 2 1/2	D 2 1/2	D 2 1/2	D 2 1/2	D 2 1/2	10
9	X	D 2 1/2	D 2 1/2	D 2 1/2	D 2 1/2	D 2 1/2	D 2 1/2	D 2 1/2	D 2 1/2	D 2 1/2	D 2 1/2	9
8	X	D 3	D 3	D 3	D 3	D 3	D 3	D 3	D 3	D 3	D 3	8
7	X	D 3	D 3	D 3	D 3	D 3	D 3	D 3	D 3	D 3	D 3	7
6	X	C 3	C 3	C 3	C 3	C 3	C 3	C 3	C 3	C 3	C 3	6
5	X	C 3	C 3	C 3	C 3	C 3	C 3	C 3	C 3	C 3	C 3	5
4	X	C 3	C 3	C 3	C 3	C 3	C 3	C 3	C 3	C 3	C 3	4
3	X	C NU	C NU	C NU	C NU	C NU	C NU	C NU	C NU	C NU	C NU	3
2	X	C NU	C NU	C NU	C NU	C NU	C NU	C NU	C NU	C NU	C NU	2
1	X X	NU NU	NU NU	NU NU	NU NU	NU NU	NU NU	NU NU	NU NU	NU NU	NU NU	1
0	NU NU	NU NU	X X	X X	X X	X X	X X	X X	X X	X X	X X	0
	0	1	2	3	4	5	6	7	8	9	10	

HORIZONTAL RUN IN FEET

LP Gas Venting Chart

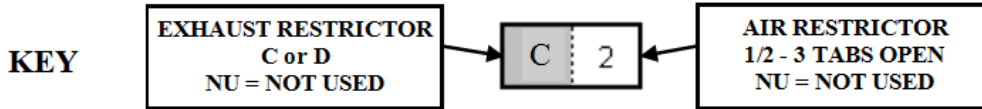

VERTICAL RISE (FEET)

	0	1	2	3	4	5	6	7	8	9	10	
30	D 1/2	X X	X X	X X	X X	X X	X X	X X	X X	X X	X X	30
29	D 1/2	D 1/2	X X	X X	X X	X X	X X	X X	X X	X X	X X	29
28	D 1/2	D 1/2	D 1/2	X X	X X	X X	X X	X X	X X	X X	X X	28
27	D 1/2	D 1/2	D 1/2	D 1/2	X X	X X	X X	X X	X X	X X	X X	27
26	D 1/2	D 1/2	D 1/2	D 1/2	D 1/2	X X	X X	X X	X X	X X	X X	26
25	D 1/2	D 1/2	D 1/2	D 1/2	D 1/2	D 1/2	X X	X X	X X	X X	X X	25
24	D 1	D 1	D 1	D 1	D 1	D 1	D 1	X X	X X	X X	X X	24
23	D 1	D 1	D 1	D 1	D 1	D 1	D 1	D 1	X X	X X	X X	23
22	D 1	D 1	D 1	D 1	D 1	D 1	D 1	D 1	D 1	X X	X X	22
21	D 1	D 1	D 1	D 1	D 1	D 1	D 1	D 1	D 1	D 1	X X	21
20	D 1	D 1	D 1	D 1	D 1	D 1	D 1	D 1	D 1	D 1	D 1	20
19	D 1	D 1	D 1	D 1	D 1	D 1	D 1	D 1	D 1	D 1	D 1	19
18	D 1	D 1	D 1	D 1	D 1	D 1	D 1	D 1	D 1	D 1	D 1	18
17	D 1 1/2	D 1 1/2	D 1 1/2	D 1 1/2	D 1 1/2	D 1 1/2	D 1 1/2	D 1 1/2	D 1 1/2	D 1 1/2	D 1 1/2	17
16	D 1 1/2	D 1 1/2	D 1 1/2	D 1 1/2	D 1 1/2	D 1 1/2	D 1 1/2	D 1 1/2	D 1 1/2	D 1 1/2	D 1 1/2	16
15	D 1 1/2	D 1 1/2	D 1 1/2	D 1 1/2	D 1 1/2	D 1 1/2	D 1 1/2	D 1 1/2	D 1 1/2	D 1 1/2	D 1 1/2	15
14	D 1 1/2	D 1 1/2	D 1 1/2	D 1 1/2	D 1 1/2	D 1 1/2	D 1 1/2	D 1 1/2	D 1 1/2	D 1 1/2	D 1 1/2	14
13	D 1 1/2	D 1 1/2	D 1 1/2	D 1 1/2	D 1 1/2	D 1 1/2	D 1 1/2	D 1 1/2	D 1 1/2	D 1 1/2	D 1 1/2	13
12	D 1 1/2	D 1 1/2	D 1 1/2	D 1 1/2	D 1 1/2	D 1 1/2	D 1 1/2	D 1 1/2	D 1 1/2	D 1 1/2	D 1 1/2	12
11	D 2	D 2	D 2	D 2	D 2	D 2	D 2	D 2	D 2	D 2	D 2	11
10	D 2	D 2	D 2	D 2	D 2	D 2	D 2	D 2	D 2	D 2	D 2	10
9	X X	D 3	D 3	D 3	D 3	D 3	D 3	D 3	D 3	D 3	D 3	9
8	X X	D 3	D 3	D 3	D 3	D 3	D 3	D 3	D 3	D 3	D 3	8
7	X X	D 3	D 3	D 3	D 3	D 3	D 3	D 3	D 3	D 3	D 3	7
6	X X	D 3	D 3	D 3	D 3	D 3	D 3	D 3	D 3	D 3	D 3	6
5	X X	C 3	C 3	C 3	C 3	C 3	C 3	C 3	C 3	C 3	C 3	5
4	X X	C 3	C 3	C 3	C 3	C 3	C 3	C 3	C 3	C 3	C 3	4
3	X X	C NU	C NU	C NU	C NU	C NU	C NU	C NU	C NU	C NU	C NU	3
2	X X	C NU	C NU	C NU	C NU	C NU	C NU	C NU	C NU	C NU	C NU	2
1	X X	NU NU	NU NU	NU NU	NU NU	NU NU	NU NU	NU NU	NU NU	NU NU	NU NU	1
0	NU NU	NU NU	X X	X X	X X	X X	X X	X X	X X	X X	X X	0
	0	1	2	3	4	5	6	7	8	9	10	

HORIZONTAL RUN IN FEET

Venting Chart Worksheet

A. FUEL TYPE: NATURAL GAS LP GAS (PROPANE)

B. TOTAL VERTICAL VENT RISE (MEASURED FROM HORIZONTAL CENTERLINE OF VENT OPENING ON THE BACK OF THE FIREPLACE TO THE HORIZONTAL CENTERLINE OF THE VENT CAP (FOR HORIZONTAL VENT CAPS) OR TO THE FLANGE ON THE CAP (FOR VERTICAL CAPS)): _____ FEET

C. TOTAL HORIZONTAL VENT RUN (MEASURED FROM THE VERTICAL CENTERLINE OF THE VENT OPENING ON THE BACK OF THE FIREPLACE TO THE FLANGE ON THE CAP (FOR HORIZONTAL CAPS) OR TO THE VERTICAL CENTERLINE OF THE CAP (FOR VERTICAL CAPS)): _____ FEET

NOTE: THE VERTICAL VENT RISE AND HORIZONTAL VENT RUN ARE THE OFFSETS IN THE LOCATIONS OF VENT CAP RELATIVE TO THE VENT OPENING ON THE FIREPLACE. VENT PIPE THAT RUNS AT 45° HAS BOTH A VERTICAL RISE AND HORIZONTAL RUN. SNORKEL CAPS HAVE BUILT-IN VERTICAL RISE THAT MUST BE COUNTED.

D. TOTAL NUMBER OF 90° ELBOWS: _____ **NOTE: SNORKELS COUNT AS 2- 90° ELBOWS**

E. TOTAL NUMBER OF 45° ELBOWS: _____

TERMINATION (CAP) TYPE: HORIZONTAL VERTICAL SNORKEL

VENT BRAND:

- Simpson DuraVent GS/Pro® Selkirk Direct-Temp® Security Secure AmeriVent Direct™
 Metal Fab Direct Vent ICC EXCEL Direct

VENT CAP MODEL NO: _____ **NOTE: SEE APPROVED VENT CAPS ON PAGE 8**

EXHAUST AND AIR INLET RESTRICTORS CALCULATOR

A. Fuel Type

B. Total Vertical Vent Rise: _____ feet

C. Total Horizontal Vent Run (Actual): _____ feet

D. 90° Elbows Needed: _____

E. 45° Elbows Needed: _____

F. Total 90° Elbows Equivalent: $D + (E \times \frac{1}{2}) =$ _____

G. 90° Elbows in Excess of 2: $F - 2 =$ _____

H. Additional Horiz. Feet Equivalent: $G \times 3 =$ _____ feet

I. Horizontal Vent Run (Equivalent): $C + H =$ _____ feet

Find _____ Chart Settings for:

B. _____ feet Vertical Rise and I. _____ feet Horizontal Run (Equivalent).

Exhaust Restrictor Required: N Y IF YES: A or B

Air Restrictor Required: N Y IF YES: Number of Tabs Open: _____

Venting Chart Worksheet Examples

A. Fuel:	Natural Gas
B. Total Vertical Vent Rise:	0 feet
C. Total Horiz. Vent Run (Actual):	1 feet
D. 90° Elbows Needed:	0
E. 45° Elbows Needed:	0
F. Total 90° Elbows Equivalent :	0
G. 90° Elbows in Excess of 2:	0
H. Additional Horiz. Feet Equivalent	0
I. Total Horizontal Vent Run (Equivalent):	1
Use Natural Gas Chart Settings for:	
0 feet Vertical Rise, 0 feet Horizontal Run.	
Exhaust Restrictor Used:	Restrictor Not Used
Air Restrictor Tabs Open:	Restrictor Not Used

A. Fuel:	LP Gas
B. Total Vertical Vent Rise:	1 feet
C. Total Horizontal Vent Run (Actual):	3 feet
D. 90° Elbows Needed:	2
E. 45° Elbows Needed:	0
F. Total 90° Elbows Equivalent:	$2 + (0 \times \frac{1}{2}) = 2$
G. 90° Elbows in Excess of 2:	$2 - 2 = 0$
H. Additional Horiz. Feet Equivalent:	$0 \times 3 = 0$
I. Total Horiz. Vent Run (Equivalent):	$3 + 0 = 3$
Use LP Gas Chart Settings for:	
1 feet Vertical Rise, 3 feet Horizontal Run.	
Exhaust Restrictor Used:	Restrictor Not Used
Air Restrictor Tabs Open:	Restrictor Not Used

A. Fuel:	Natural Gas
B. Total Vertical Vent Rise:	12 feet
C. Total Horiz. Vent Run (Actual):	0 feet
D. 90° Elbows Needed:	1
E. 45° Elbows Needed:	0
F. Total 90° Elbows Equivalent :	0
G. 90° Elbows in Excess of 2:	0
H. Additional Horiz. Feet Equivalent	0
I. Total Horizontal Vent Run (Equivalent):	0
Use Natural Gas Chart Settings for:	
12 feet Vertical Rise, 0 feet Horizontal Run.	
Exhaust Restrictor Used:	D
Air Restrictor Tabs Open:	2

A. Fuel:	LP Gas
B. Total Vertical Vent Rise:	10 feet
C. Total Horizontal Vent Run (Actual):	7 feet
D. 90° Elbows Needed:	2
E. 45° Elbows Needed:	2
F. Total 90° Elbows Equivalent:	$2 + (2 \times \frac{1}{2}) = 3$
G. 90° Elbows in Excess of 2:	$3 - 2 = 1$
H. Additional Horiz. Feet Equivalent:	$1 \times 3 = 3$
I. Total Horiz. Vent Run (Equivalent):	$7 + 3 = 10$
Use LP Gas Chart Settings for:	
10 feet Vertical Rise, 10 feet Horizontal Run.	
Exhaust Restrictor Required:	D
Air Restrictor Tabs Open:	2

A. Fuel:	Natural Gas
B. Total Vertical Vent Rise:	6 feet
C. Total Horizontal Vent Run (Actual):	6 feet
D. 90° Elbows Needed:	3
E. 45° Elbows Needed:	0
F. Total 90° Elbows Equivalent:	$3 + (0 \times \frac{1}{2}) = 3$
G. 90° Elbows in Excess of 2:	$3 - 2 = 1$
H. Additional Horiz. Feet Equivalent:	$1 \times 3 = 3$
I. Total Horiz. Vent Run (Equivalent)	$6 + 3 = 9$
Use Natural Gas Chart Settings for:	
6 feet Vertical Rise, 9 feet Horizontal Run.	
Exhaust Restrictor Required:	C
Air Restrictor Tabs Open:	3

A. Fuel:	LP Gas
B. Total Vertical Vent Rise:	2 feet
C. Total Horizontal Vent Run (Actual):	10 feet
D. 90° Elbows Needed:	2
E. 45° Elbows Needed:	0
F. Total 90° Elbows Equivalent:	$2 + (0 \times \frac{1}{2}) = 2$
G. 90° Elbows in Excess of 2:	$2 - 2 = 0$
H. Additional Horiz. Feet Equivalent:	$0 \times 3 = 0$
I. Total Horiz. Vent Run (Equivalent):	$10 + 0 = 10$
Use LP Gas Chart Settings for:	
2 feet Vertical Rise, 10 feet Horizontal Run.	
Exhaust Restrictor Used:	C
Air Restrictor Tabs Open:	Restrictor Not Used

The illustration below shows some of the many ways the ORION 46 fireplace may be installed in the home. This includes interior and exterior wall installations, corner installations and horizontal and vertical vent terminations.

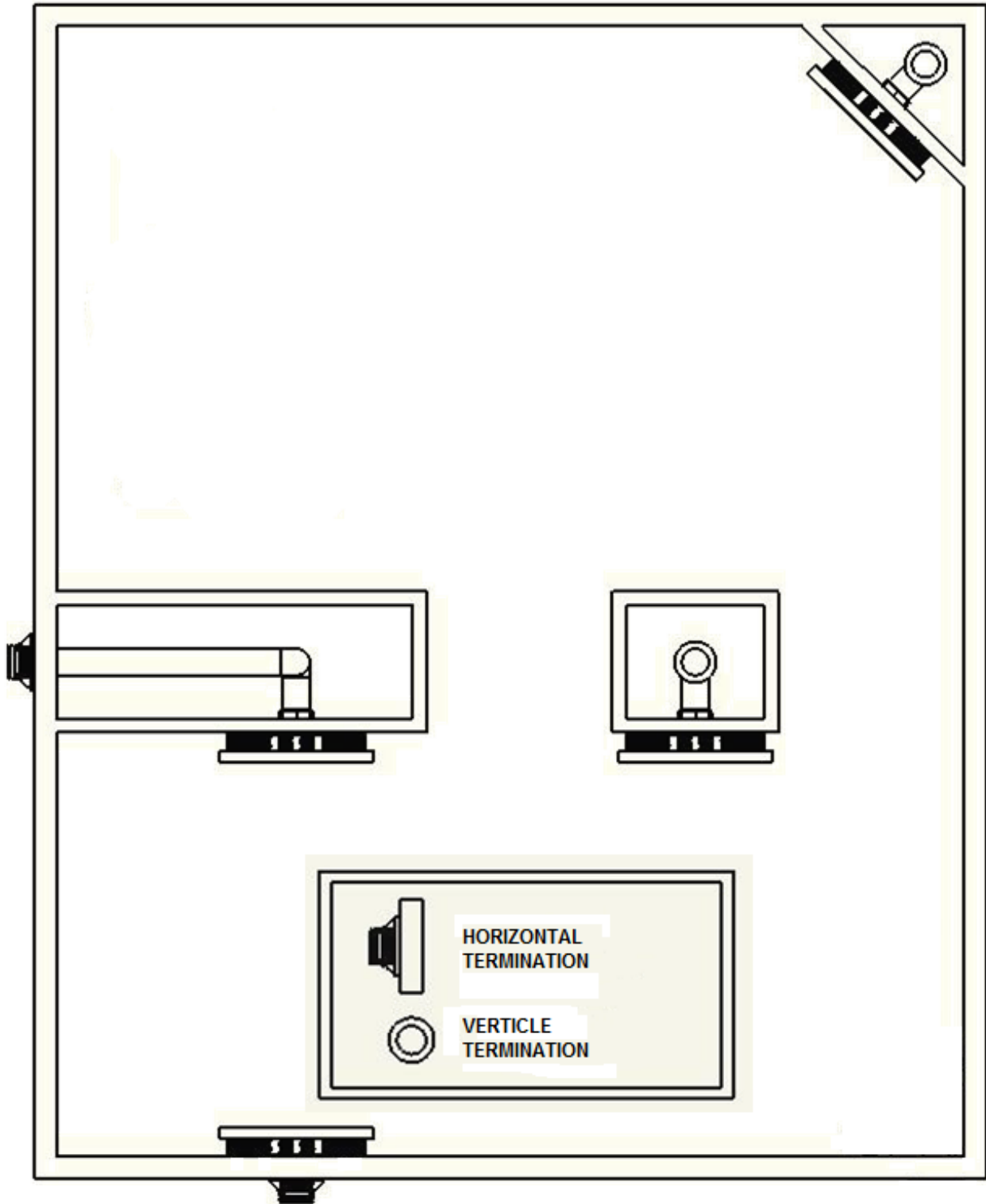

Vent Terminal Clearances

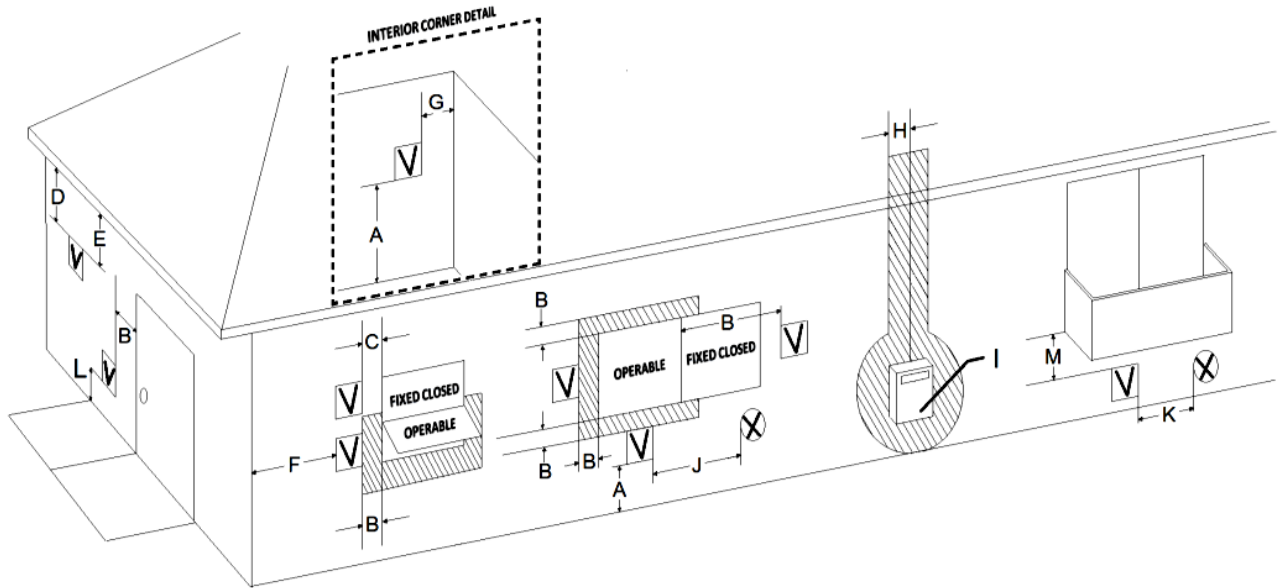

V Vent Terminal

X Air Supply Inlet

[Shaded Box] Area Where Terminal Is Not Permitted

	Canadian Installations ¹	U.S. Installations ²
A = Clearance above grade, veranda, porch, deck or balcony	12 inches (30 cm)	12 inches (30 cm)
B = Clearance to window or door that may be opened	12 inches (30 cm)	9 inches (23 cm)
C = Clearance to a permanently closed window	See Footnotes 5 & 6	See Footnote 5
D = Vertical clearance to a ventilated soffit located above the terminal within a horizontal distance of 2 feet (61 cm) from the centerline of the terminal	See Footnotes 5 & 6	See Footnote 5
E = Clearance to unventilated soffit	See Footnotes 5 & 6	See Footnote 5
F = Clearance to outside corner	See Footnotes 5 & 6	See Footnote 5
G = Clearance to inside corner	See Footnotes 5 & 6	See Footnote 5
H = Clearance to each side of centerline extended above meter/regulator assembly	3 feet (91 cm) within a height of 15 feet (4.5 m) above the regulator/meter assembly	See Footnote 5
I = Clearance to service regulator vent outlet	3 feet (91 cm)	See Footnote 5
J = Clearance to non-mechanical air supply inlet to building or the combustion air inlet to any other appliance	12 inches (30 cm)	9 inches (23 cm)
K = Clearance to a mechanical air supply inlet	6 feet (1.83 m)	3 feet (91 cm) above if within 10 feet (3 m) horizontally
L = Clearance above paved sidewalk or paved driveway located on public property	7 feet (2.12 m)	See Footnote 5
M = Clearance under veranda, porch, deck or balcony	12 inches (30 cm) See Footnote 4	See Footnote 5

Footnotes

- 1 In accordance with the current CSA B419.1, Natural Gas and Propane Installation Code
- 2 In accordance with the current ANSI Z223.1 / NFPA 54, National Fuel Gas Code
- 3 A vent shall not terminate directly above a sidewalk or paved driveway that is located between two single family dwellings and serves both dwellings.
- 4 Permitted only if veranda, porch, deck or balcony is fully open on a minimum of two sides below the floor.
- 5 Clearance in accordance with local installation codes and the requirements of the gas supplier.
- 6 Dégagement conforme aux codes d'installation locaux et aux exigences du fournisseur de gaz.

Assembly and Installation

UNPACKING AND INSTALLING THE ORION 46 WALL MOUNT FIREPLACE

The fireplace components are shipped in three cartons. By now, you will have opened the top of the first carton, removed the glass protector and this manual. You will also have found the Left and Right decorative panels. The second carton contains the vent starter pipe, vent heat shields and air and exhaust restrictors. The third carton contains the fireplace surround.

1. Using the adjacent illustrations as a guide, first lift and remove Tube 1 from the carton containing the firebox. Carefully unpack the contents of the tube and set aside. This should include the bag of glass burner media, the remote control handset, a hardware bag and relief door with gasket.
2. Next lift and remove Tube 2 from the carton. Carefully remove the contents of the tube. This includes the four decorative panels that will be attached to the fireplace during assembly.
3. Next, remove all remaining packaging materials from the carton.
4. Lift the firebox and the fireplace mounting plate as a unit up and out of the carton. The best place to lift is at sides. Remove the fireplace mounting template from the face of the fireplace. You should now have all of the parts as shown in the illustration below.
5. Next, unpack the vent starter pipe (with attached gasket), the inner and outer telescoping vent heat shields and the air and exhaust restrictors from the second carton and set aside for later use.
6. Finally, unpack the fireplace surround from the third carton and set aside on a soft surface for later use.

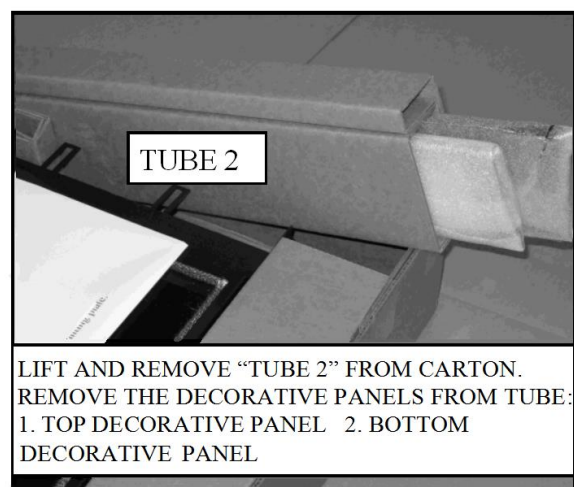
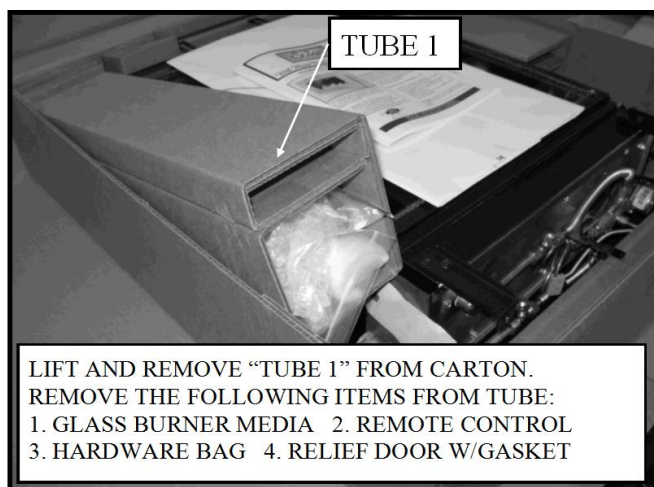
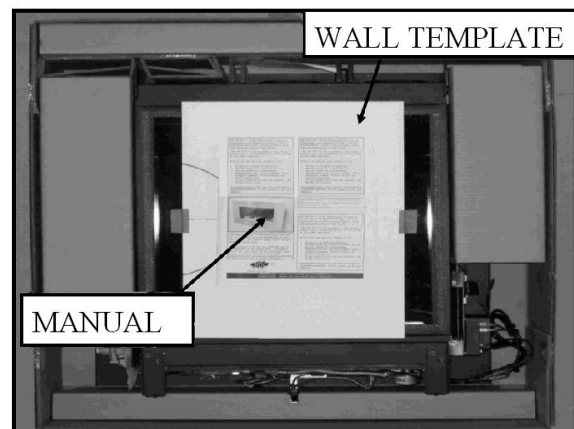
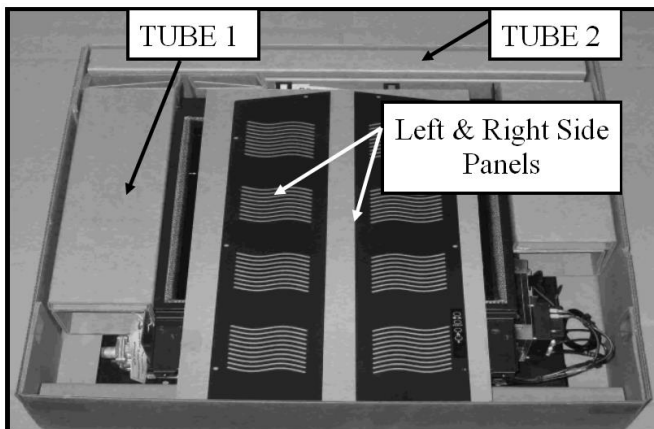

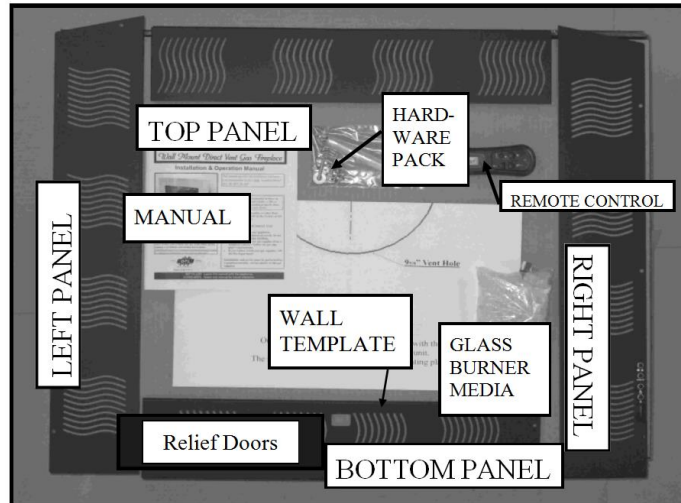

Before you begin the fireplace mounting process there are several important installation requirements that must be met. Careful planning will make the installation easier to accomplish and will reduce the chances of encountering problems after you start.

1. The fireplace is designed to be wall-mounted using four lag bolts to secure the fireplace mounting plate to the wall structure. The mounts are located 16" on center to correspond with standard building construction. If your home has non-standard construction or the location you have chosen for the fireplace does not have wall studs that correspond to location of the fireplace mounts, modifications to the wall structure will be needed. It is critical that the four lag bolts that are provided for mounting the fireplace are firmly imbedded into the wall structure at all four locations.
2. A hole must be provided in the wall for the vent to pass through. The hole must be large enough to provide 1 1/2" clearance around the outside of the vent pipe and to allow for installation of the vent heat shields that are provided with the fireplace. Follow the hole size requirements that are provided below exactly to avoid problems. If the location you have chosen does not allow for 1 1/2" clearance to wooden framing in the wall, modifications to the wall structure must be made to obtain the needed vent pipe clearance.
3. All required minimum clearances to adjacent combustible materials (including side walls, ceiling and floor) must be achieved with the position you have chosen. See the clearance information on page 6. The listed clearances are measured from the outermost front edges of the fireplace surround and not from the fireplace body or mounting plate. In addition the requirements for clearance to combustible materials inside the house, there are specific requirements and limitations that must be met for the location of the vent terminal relative to doors, windows, corners, eaves, gas supply components and other structural elements of the house. Please see page 15 for those specific requirements. Again, plan the installation in advance to avoid problems.
4. The gas supply line must be located within a specific area behind the fireplace.

Once you are certain that the location you have chosen meets all the necessary mounting and safety requirements, you can begin the installation.

1. Tape or pin the installation template to the wall in the position where the fireplace is to be mounted (see image below) Note: It is important that the fireplace is mounted in a level position. Use a spirit level placed

on the cross-hairs in the upper mounting holes on the template and adjust the template position until the mounting holes are level. Refer to the adjacent illustration.

- Next, carefully transfer the location of the upper and lower mounting holes that you will use for your installation (a minimum of 6 mounting holes required). Use a sharp nail, awl or pin to pierce the template on the mounting hole cross-hairs to insure an accurate transfer to your wall.

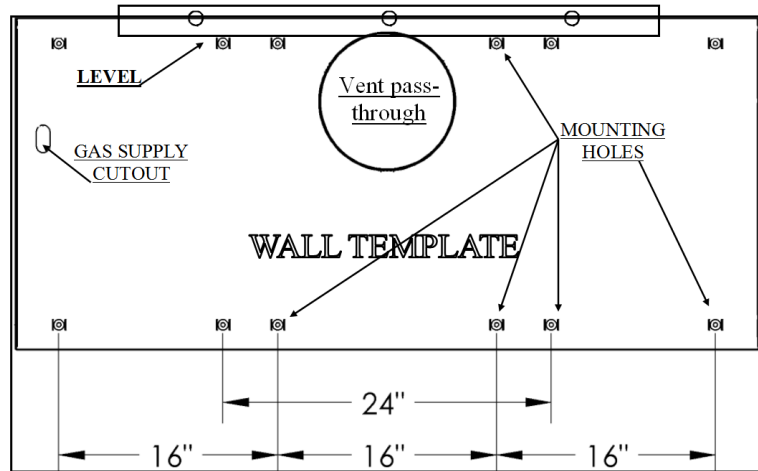

- Next transfer the location for the center of the vent pass-through hole on the wall. Also transfer at least one point on the diameter of the vent pass-through circle. This will make it easier to scribe the circle later.
- Finally, transfer the location of the gas supply line.
- Remove the template and circle the transferred locations with a pencil or marker.

Vent Pass-Through (Parallel Wall Installation on an Outside Wall)

- An unobstructed wall pass-through is required to allow for a safe installation of the fireplace vent components. This will necessitate removal of a portion of the interior wall covering (e.g., sheetrock or plaster and lath), outer wall sheathing and outer wall covering and any adjacent internal wall materials (like insulation).
- Scribe a 10 1/2" diameter hole around the vent pass-through center mark using a compass.
- Use a long drill (1/8" diameter) that is held square and level to the inside wall to transfer the vent pass-through center location from the inner wall covering through to the outer wall sheathing and outer wall covering.
- Carefully cut the inner wall covering along the scribed line and remove the circular wall piece. Note: It is important to locate electrical wiring in the wall before beginning the installation process. An electrician should be consulted if there is any question about wiring locations. Failure to locate and protect wiring during the installation process may result in electrical shock or fire.
- Remove any insulation materials from wall in the area defined by the pass-through hole.
- Building codes in your area may require that you add blocking above and below the vent opening. The blocking should be above and below the 10 1/2" vent opening you made in the wall and should not obstruct that opening. The blocking should extend to adjacent wall studs.
- Next, mark and cut a 10 1/2" diameter hole through the outer wall covering and sheathing using the locating hole you drilled in Step 2.
- Follow the instructions included with the vent termination (cap) to remove the appropriate amount of outer wall covering (siding) or to install the vinyl siding shield if used. Do not install the chimney cap at this point.

Vent Pass-Through (Parallel Wall Installation on an Interior Partition Wall)

1. An unobstructed wall pass-through is required to allow for a safe installation of the fireplace vent components. This will necessitate removal of a portion of the interior wall covering (e.g., sheetrock or plaster and lath), on both sides of the partition wall and any adjacent internal wall materials (like insulation).
2. Scribe a 10 1/2" diameter hole around the vent pass-through center mark using a compass.
3. Use a long drill (1/8" diameter) that is held square and level to the inside wall to transfer the vent pass-through center location from the inner wall covering through to the wall covering on the back side of the partition wall.
4. Carefully cut the inner wall covering along the scribed line and remove the circular wall piece. Note: It is important to locate electrical wiring in the wall before beginning the installation process. An electrician should be consulted if there is any question about wiring locations. Failure to locate and protect wiring during the installation process may result in electrical shock or fire.
5. Remove any insulation materials from wall in the area defined by the pass-through hole.
6. Building codes in your area may require that you add blocking above and below the vent opening. The blocking should be above and below the 10 1/2" vent opening you made in the wall and should not obstruct that opening. The blocking should extend to adjacent wall studs.
7. Next, mark and cut a 10 1/2" diameter hole through the wall covering on the back side of the partition wall using the locating hole you drilled in Step 2.
8. When installing the fireplace on a partition wall, the venting may be penetrating one or more interior walls, an exterior wall, the ceiling or the roof.
9. It is important to lay out the locations of all vent pass-through's before you begin the installation to insure that the venting will line-up correctly and that the walls and ceiling meet the needed clearances to the vent pipe.
10. The vent pass-through in the partition wall where the fireplace is mounted must be done in accordance with the instructions for a parallel wall installation on an outside wall, following steps 1 through 6.

Vent Pipe Heat Shields

Special telescoping double heat shields for the vent pipe are provided with the ORION 46 fireplace. These heat shields are a critical part of a safe installation. They are designed to protect combustible materials in the wall immediately behind the fireplace. All 4 components of these pass through heat shields must be installed on every installation.

Gas Supply Line

1. Once the vent pass-through (or pass-through's) are finished, the gas supply line should be installed. The supply line should exit the wall that the fireplace will be installed on at the location specified on the installation template. We suggest the installation of a shut-off valve in the supply line between the wall and the connection to the fireplace. Your professional gas installer or local gas company will determine the specific requirements for the gas supply line as the requirements may vary in different locations. In every case, the installation must conform with local codes or, in the absence of local codes, with the *National Fuel Gas Code, ANSI Z223.1* or the *Canadian Installation Code, CAN/CGA B149*.

Installing the Fireplace Mounting Plate on the Wall

1. The fireplace mounting plate is attached to the wall structure using four 1/4" X 2" long lag bolts and large diameter washers that are provided with the fireplace. It is important to use the included hardware as the full weight of the fireplace is supported by the mounting plate.
2. Drill a 5/32" diameter pilot hole at each of the mounting hole locations that you marked using the template. The pilot holes should be the full depth of the lag bolts. Be sure that there is solid wood at each mounting location. If not, the wall should be reconstructed to provide the needed support.
3. Before the mounting plate can be lagged to the wall the two tabbed sections of the telescoping vent pipe heat shields that you set aside earlier must be attached to the mounting plate. Each heat shield half is held in place with three sheet metal screws (provided). The inner shield half (smaller diameter) is installed from the front of the mounting plate. Slide the inner heat shield half through the vent pipe opening in the mounting plate. Align the three tabs with the pilot holes in the mounting plate (as shown in the adjacent illustration) and install the three screws.
4. The outer vent pipe heat shield half (larger diameter) is installed on the rear of the mounting plate. Slip the outer shield half over the inner shield and align and install the three screws. See the adjacent illustration.
5. The fireplace mounting plate is now ready to be lagged to the wall structure.
6. With a helper pick up and align the mounting plate over the gas supply line and line up with the four mounting lag bolt pilot holes. These holes are in recessed bosses.
7. Using the lag bolts and washers provided with the fireplace, install the top lag bolts (with washers) first, followed by the lower ones. Use a 7/16" socket wrench to tighten the lag bolts.

Note: It may be helpful to put a light coating of dish or hand soap on the lag bolts to reduce resistance when tightening.

8. At this point, check to be sure that there is a 3/8" air gap between the entire flat back surface of the mounting plate and the wall surface. The gap is critical to a safe installation and if the gap is obstructed in any way, remove the obstruction before proceeding.
9. Next check that the brackets on the mounting plate that actually hold the fireplace are level, again using a spirit level. If the brackets are not perfectly level, you can adjust the right bracket by loosening the bracket fasteners and moving the bracket until it is level with the left bracket. Remember to tighten the bracket fasteners once you have achieved a level position.

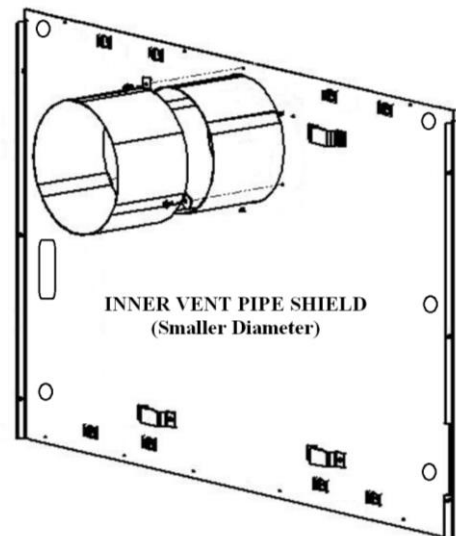
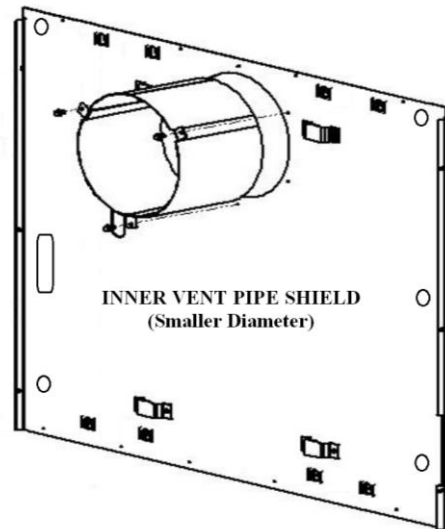

10. The next step is to install the vent starter pipe onto the fireplace.
11. Remove the glass panel and glass frame assembly from the front of the firebox by loosening and removing the four glass frame fasteners that are located along the top edge of the glass frame.
12. While holding the glass panel and glass frame along the outer edges, tip the top of the glass frame forward a few inches.
13. Wrap your fingers around the frame and hold the glass and frame together while you lift the frame up and out of the lower glass retainer. Set the glass and frame assembly aside in a safe place.
14. Carefully place the fireplace with the front down on a protected floor.
15. At this point, it is necessary to determine whether your installation will require the addition of flow restrictors to the combustion air inlet system or the exhaust outlet or both. Refer to the venting section that starts on page 8 to make that determination.
16. If your installation does not require any restrictors, place the vent starter pipe gasket on the back of the fireplace aligning the holes in the gasket with the pilot holes on the rear of the fireplace.
17. Align the inner pipe of the vent starter pipe with the exhaust outlet pipe on the fireplace. The vent pipe will fit tightly over the fireplace pipe. Gently push the starter pipe on to the fireplace pipe until the outer pipe flange makes contact with the starter pipe gasket. Be sure that the holes in the starter pipe flange align with the gasket and pilot holes. When the flange contacts the gasket, install the four fasteners provided with the starter pipe.
18. If your installation does require an air restrictor or exhaust restrictor or both, these must be installed before you install the vent starter pipe. Again, refer to the venting information starting on page 8 to determine the specific restrictor requirements for your specific installation.
19. The exhaust restrictor is installed by placing it through the exhaust outlet pipe and resting it on the internal baffle in the firebox. It is held in place with a movable retainer clip. Simply hold the restrictor down against the baffle and push the retainer up and tighten screw to secure the restrictor. Note: Please take care to insure that the exhaust restrictor is centered in the exhaust outlet. Improper alignment could adversely affect the appearance of the flames. Refer to the adjacent illustrations for placement of the exhaust restrictor and clip.

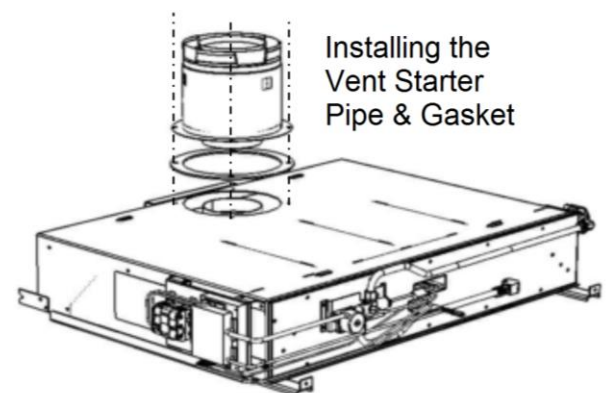
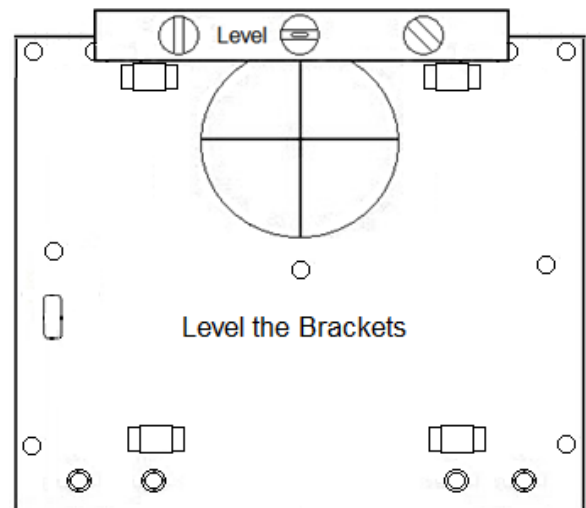
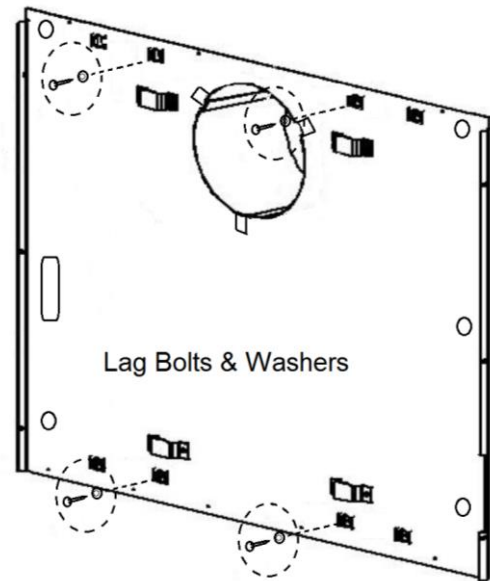

20. If the air restrictor ring is required, first determine the number of tabs that must be bent open. Before bending any tabs, align the mounting holes in the ring over the four pilot holes on the back of the fireplace. When selecting the tabs to bend, it is important to maintain the most symmetrical pattern possible. The first tabs bent must be opposite each other and oriented horizontally. If only one tab is specified, orient the ring over the pilot holes so the split tabs are oriented horizontally and bend up two opposing half-tabs. Additional tabs should be evenly spaced relative to the first two. With the appropriate tabs bent, re-align the mounting holes in over the pilot holes keeping the proper orientation AND with the bent tabs facing away from the fireplace body.



21. Place the vent starter pipe gasket on the back of the fireplace aligning the holes in the gasket with the pilot holes on the rear of the fireplace.

22. Align the inner pipe of the vent starter pipe with the exhaust outlet pipe on the fireplace. The vent pipe will fit tightly over the fireplace pipe. Gently push the starter pipe on to the fireplace pipe until the outer pipe flange makes contact with the vent pipe gasket. Be sure that the holes in the starter pipe flange align with the gasket and pilot holes. When the flange contacts the gasket, install the four fasteners provided with the starter pipe.

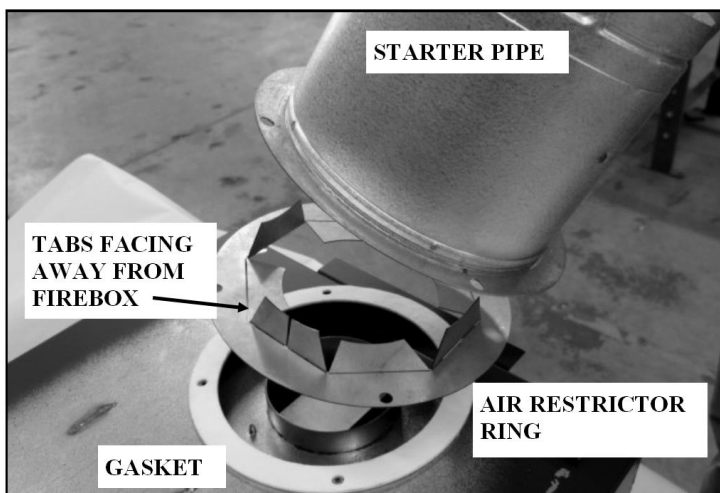

23. You are now ready to install the fireplace on the mounting plate. This will require a helper as the fireplace is quite heavy. Lift the fireplace up and guide the vent pipe into the vent pipe opening in the mounting plate. The vent pipe must be at the highest location possible in the vent pipe opening (almost touching the inner vent pipe heat shield) to allow the mounting tabs on the rear of the fireplace to clear the top of the mounting brackets on the mounting plate. Refer to the adjacent illustration.
24. While looking in from the sides, guide the upper and lower mounting tabs on the back of the fireplace into the corresponding brackets on the mounting plate. When the tabs and brackets are aligned, push the fireplace down and in to engage the tabs in the brackets. Note: The weight of the fireplace is carried only on the top brackets. The bottom brackets function simply to keep the bottom of the fireplace from moving. Refer to the adjacent illustration.
25. If the fireplace is properly positioned on the brackets the vent starter pipe and vent heat shields should be concentric when viewed through the vent pass-through in the wall. Go outside and look in the hole to confirm this. If you are mounting the fireplace on a 45° partition wall, look in the pass-through using a mirror if needed. If the vent starter pipe and vent pipe heat shields do not appear to be concentric, check to be sure that the mounting tabs on the fireplace are all fully engaged in the brackets on the mounting plate and that the upper two tabs are sitting down on the upper brackets. If they are not, adjust the fireplace until they are.

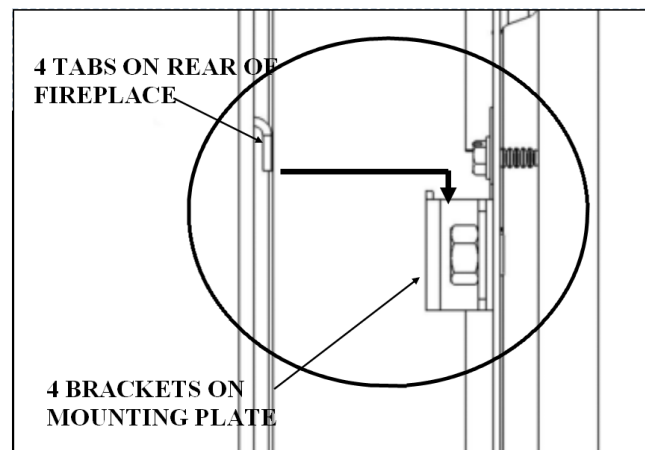
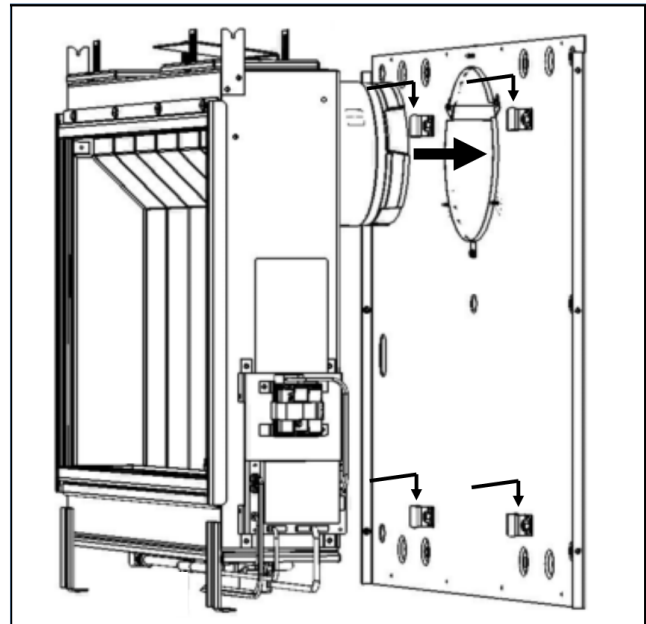

VENT PIPE AND SHIELDS SHOULD BE CONCENTRIC IF THE FIREPLACE IS PROPERLY INSTALLED



Installing the Outer Vent Heat Shields and Vent Termination (Parallel Installation on Outside Wall)

1. Before you install the horizontal vent termination, you must first install the second halves of the two telescoping vent pipe heat shields. Each shield half simply slips over the half you previously attached to the fireplace mounting plate and can now be seen inside the vent pass-through in the wall.
2. Install the outer shield first and the inner second. Leave about 1-1/4" of the shields protruding past the house sheathing.
3. Install the horizontal vent termination (vent cap) by first removing the two mounting straps as they will not be used. Be sure the arrow on the cap (if present) is pointing up and reconfirm that all the vent cap location requirements per page 14 and the vent manufacturers requirements are met.

NOTE: A piece of insulating material is supplied with the vent kit. It is very important that this insulation be fitted between the back of the Horizontal Vent Termination and the wall as shown.

4. Slip the inner and outer vent termination pipes onto the vent starter pipe taking care to align the inner and outer pipes to prevent damage.
5. Slide the vent termination (cap) into the siding recess (or vinyl siding shield) until it bottoms out. Note: The rear surface of the vent termination will push the telescoping vent pipe heat shields inward. When the vent termination is in place the heat shields will just touch the rear surface of the termination.
6. Pull the vent cap away from the sheathing and install a small bead of non-hardening silicone sealer around the cap perimeter. Push the cap in place.
7. Install the mounting screws (included with the cap) to hold the vent cap to the sheathing. See the venting

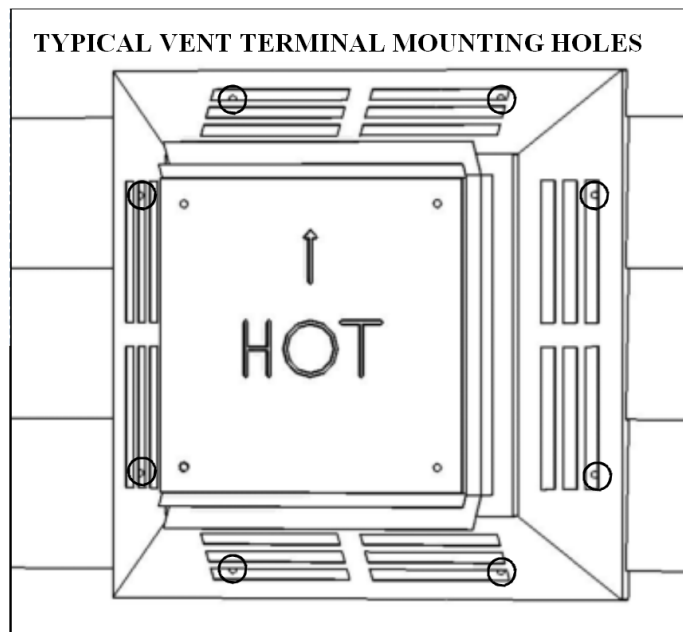
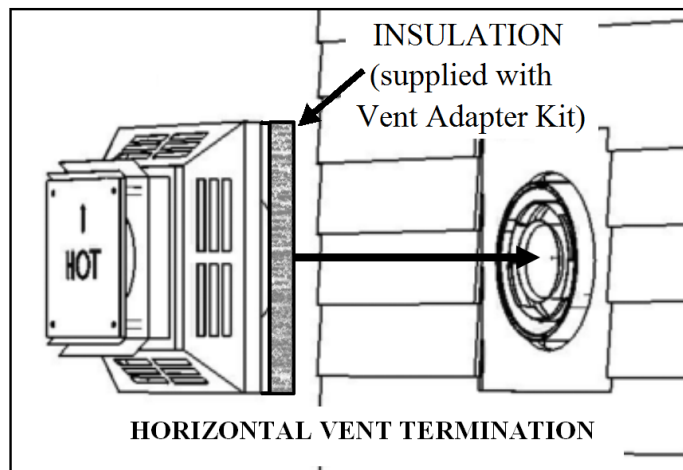
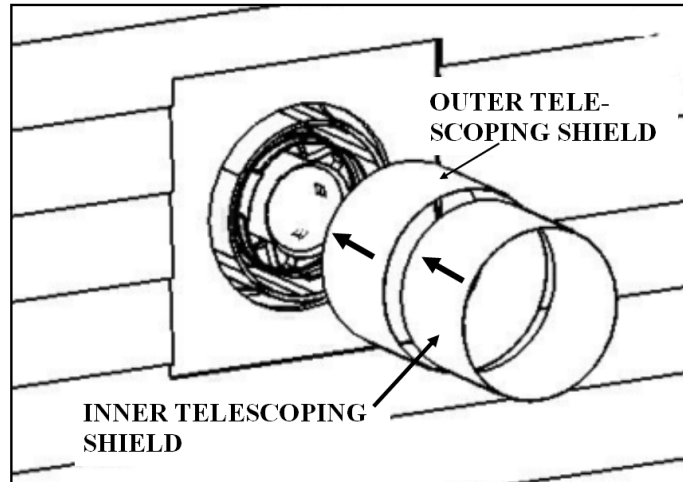

manufacturer's instructions for the location of the mounting holes. Typical mounting hole locations are shown in the adjacent illustration. See the venting manufacturer's instructions for more information or if using the vinyl siding shield.

Installing the Outer Vent Heat Shields (Partition Wall Installation)

1. Before you install the additional vent pipe and elbow(s) that will complete the venting installation, you must first install the second sections of the vent pipe heat shields to protect the combustible materials around the vent pipe pass-through in the partition wall that the fireplace is mounted on. Each shield half simply slips over the half you previously attached to the fireplace mounting plate and that can now be seen inside the vent pass-through in the partition wall.
2. Install the outer shield first and the inner second. Leave at least 2" of both shields protruding past the partition wall framing or wall covering. See the illustration on page 24.

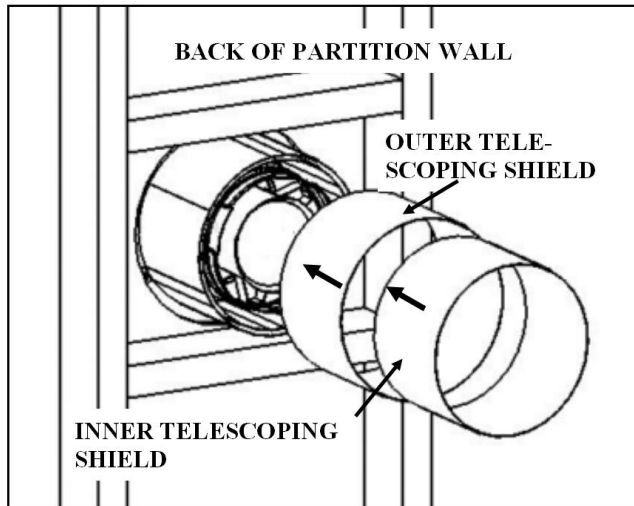

Vent Pipe and Vent Termination Installation (Partition Wall Installation)

1. The specific details of the vent configuration from the vent starter pipe on the fireplace to the horizontal or vertical vent termination (cap) when the fireplace is installed on an interior wall of the house will vary depending on the location of the fireplace on the wall, what is on the back side of the wall, where the vent termination will be located (roof or exterior wall) and on other code requirements for the location of the vent termination as shown page 15. However, the maximum vent length, measured along the centerline of the pipe, from the back of the fireplace to the start of the vent termination cannot exceed 30 feet, including a maximum of 20 feet of vertical rise and a maximum of 10 feet of horizontal run. If more than two 90° elbows (or equivalent 45° elbows) are needed for your installation, the maximum amount of horizontal run allowed is reduced. See the venting section starting on page 8 for specific information. It is important to plan the installation in advance so that you can accurately locate the any wall or ceiling pass-through's and the vent termination on the exterior wall or roof. The vent pipe sections are available only in certain increments of length and in adjustable length sections. Plan carefully before you start!
2. You will find it helpful to leave access to the area behind the partition wall to facilitate installation of the vent components. The pipe sections may have twist lock connections which will be difficult to execute without good access.
3. Be sure that the two vent pipe heat shields extend at least 2" beyond the rear side of the partition wall adjacent to the fireplace after the venting is installed.
4. Maintain a minimum 1 1/2" unobstructed air space around the vent pipe where it passes through other interior walls, the ceiling, the exterior wall or the roof.
5. Note: Vent manufacturer's instructions and some building codes may require the addition of blocking above and below all wall pass-throughs, the addition of vent manufacturer supplied fire stops, wall thimbles, attic insulation shields, interior trim collars, vent support brackets, or other components. Please check with the authority having jurisdiction in your area when planning the venting installation to determine the specific code requirements and exact venting components that are required for your installation.

Fuel Conversion

This appliance ships from the factory configured for use with Natural Gas. If use with Propane is desired, the unit is field convertible to Propane by using a fuel conversion kit.

WARNING: Gas connections must be performed by a qualified service technician.

PART #	DESCRIPTION	CONVERSION KIT CONTENTS		
99-56201	Orion 46 Fuel Conversion Kit	#27 Pilot Orifice - 1ea.	#53 LP Burner Orifice - 1ea.	#8 Screw - 1ea.

WARNING: Before servicing the appliance, shut off gas and electrical power to the unit.

- To access the burner, follow the screen and glass removal procedure shown on page 44.

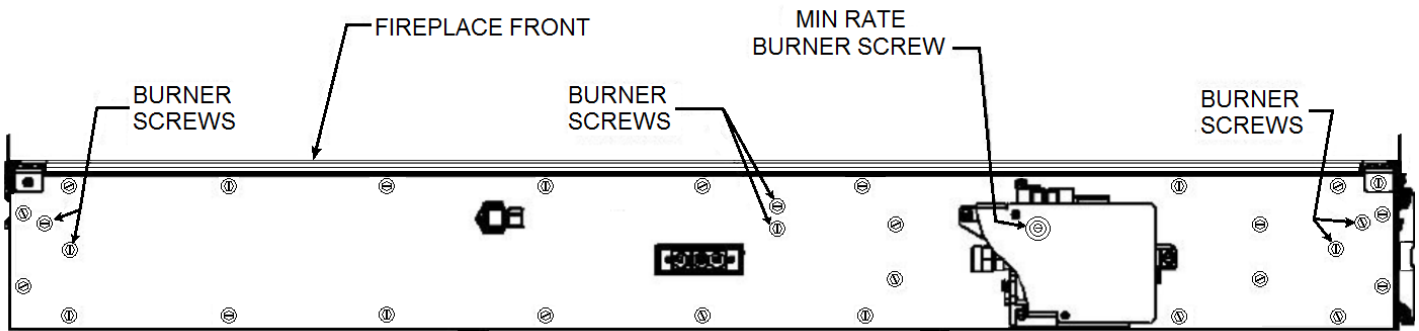

Location of the burner mounting screws looking up at the underside of the fireplace.

- Using a 5/16" nut driver, remove the six (6) #10 sheet metal burner mounting screws indicated in the image above.
- Slide the burner to the right and lift up to remove.



- Remove the two (2) #10 sheet metal screws holding the pilot assembly in place and carefully lift the assembly into the firebox.
- Using a 10mm wrench, remove the pilot gas line to access the orifice.

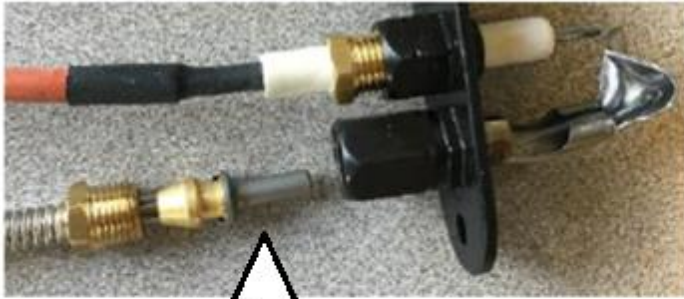

Pilot Orifice



Pilot Mechanism Re-assembled

6. Remove the existing pilot orifice and replace with the #27 provided in this kit.
7. Reinstall and tighten the pilot gas line then reinstall the pilot assembly making sure the gasket is intact.
8. Remove the #8 screw holding the NG air collar to the burner tube and remove the collar. Reinstall the #8 screw in the burner tube (a replacement screw is included in this kit).



NG Air Collar Installed



NG Air Collar Removed (Set for LP)

9. Using a 9/16" deep socket, replace the burner orifice in the firebox with the #53 orifice included in this kit.
10. Reinstall the burner in the fireplace and tighten six (6) screws removed in step #2 above.
11. Using a flat tip screw driver, remove the fuel conversion screw from the valve, switch the plug to LP and reinstall as shown below.



Location of the Fuel Conversion Screw (Under the fireplace)

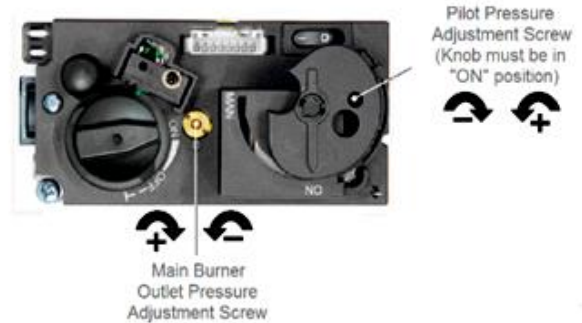

Do not remove using small, center screw head. USE ONLY THE OUTER SLOTS.

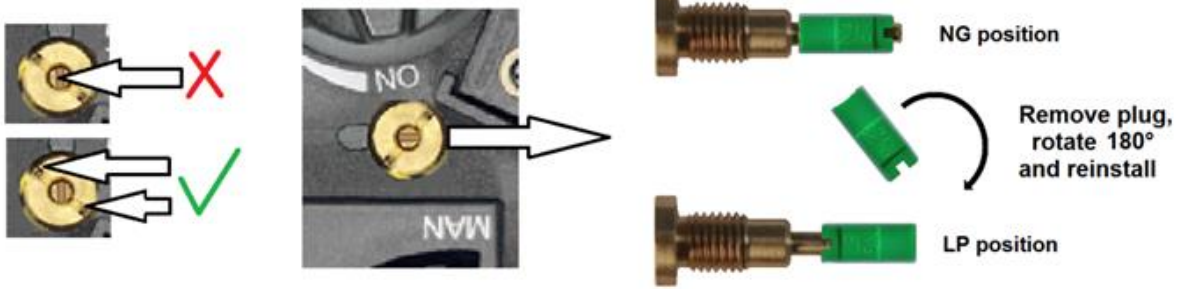

Remove Fuel Conversion Screw, slide plug off, flip, re-install plug and screw

Gas Flow Adjustment

After completion of the fuel conversion, it is necessary to check the HI and LO pressures at the valve and may be necessary to adjust one or both.

1. Install a gas gauge (Manometer) on the outlet pressure tap on the valve.
2. Light the fireplace using the remote handset.
3. With the fireplace on HI, set the maximum pressure to **10.0" w.c. (2.5kPa)** by adjusting the small flat head screw in the center of the fuel conversion screw. Use only an appropriately sized jeweler's screwdriver.

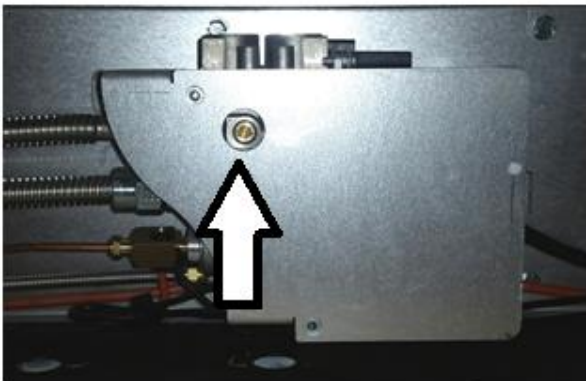

Location of Low Pressure Adjust Screw (Under the fireplace)

4. Quickly press the small flame button on the remote to set the fireplace to LO. Adjust the minimum rate to **4.7" w.c. (1.17kPa)** by turning the low pressure adjustment screw with a 4mm allen key as shown above.
5. When Hi and Lo pressure adjustments are complete, close the pressure tap(s) on the valve by turning the screws clockwise. Check all connections/pressure taps for leaks.

Gas Connection

1. Verify that the gas type is correct for the fireplace by looking at the rating plate that is attached to the right side of the fireplace, adjacent to the control battery pack. Note: The fireplace is shipped from the factory equipped to burn the fuel listed on the rating plate. Fuel conversion in the field is not allowed.
2. The gas connection should now be made from the gas supply line to the inlet regulator on the fireplace. Use only a qualified gas installer to make the connection.
3. The fireplace is shipped from the factory with a 3/8" tube OD (male) connection.
4. The gas supply piping should have a separate gas shut-off valve and a 1/8" NPT plugged tapping upstream of the valve. We recommend installing a shut-off valve between the gas supply line where it penetrates the wall / fireplace mounting plate and the inlet to the regulator on the fireplace. This will allow gas to be shut-off to the fireplace by simply removing the fireplace surround to gain access to the shut-off valve.
5. The fireplace and its inlet regulator and main burner valve must be disconnected from the gas supply piping system during any pressure testing of that system at test pressures in excess of 1/2 psi (3.5kPa).
6. The fireplace must be isolated from the gas supply piping system by closing the gas shut-off valve during any pressure testing of the gas supply system at test pressures equal to or less than 1/2 psi (3.5kPa). After the gas supply has been connected, use a commercial gas leak detector or apply a soapy water solution to all the fittings to check for gas leaks. Never use a flame to test for leaks.

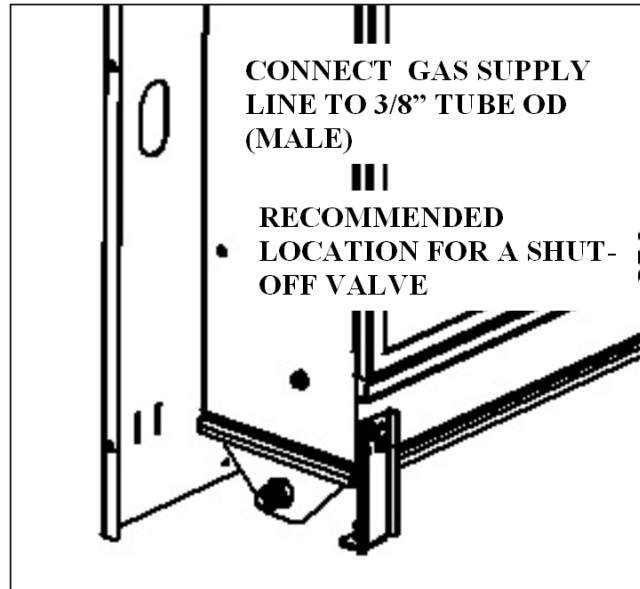

Installing or Replacing the Batteries

1. The valve control module is powered by four "AA" batteries. The batteries are mounted within the Valve Receiver Module located on the right side of the fireplace attached to a drop-down mounting bracket for easy accessibility. Refer to the adjacent illustration.
2. Loosen the thumb screw on the module drop-down mounting bracket by turning counter-clockwise until the threads are fully disengaged from the base bracket.
3. Rotate the Valve Receiver Module and mounting bracket toward you 90 degrees.
4. Slide off the Battery compartment cover.
5. Install the 4 "AA" batteries, supplied, using the guides inside the battery pack to show you the correct battery orientation.

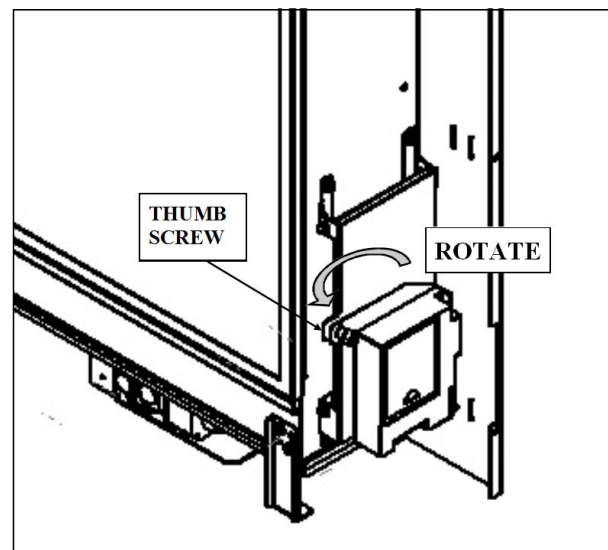

6. Replace the battery compartment cover. Rotate the Valve Receiver Module and mounting bracket into its home position and tighten the thumb screw to secure.
7. The remote handset is powered by three “AAA” batteries. The access panel is located on the back of the handset and simply snaps open to provide access to the battery compartment. Install the three batteries as shown on the label inside the remote control battery compartment.
8. Replace the remote handset access panel.



Placing the Burner Glass Media

The burner glass media poly-bag that you set aside when you unpacked the fireplace contains the correct amount of glass material to cover the burner. The entire contents of the bag should be evenly distributed over the burner tray.

1. Locate the burner in the fireplace. Refer to the adjacent illustration.
2. Carefully clip one corner of the poly-bag to form a pouring spout. The opening should be large enough to allow the glass media to flow but not so large that you can't control the flow.
3. You will notice that the burner surface is designed with turned-up edges that form a tray to hold the glass media.
4. Starting at one end, pour the glass media onto the burner tray, keeping the pouring spout on the poly-bag toward the center of the burner to avoid spillage of glass pieces over the sides of the burner. See the adjacent illustrations.
5. Once you have poured all of the glass burner media into the burner tray, carefully smooth the glass pieces out so they have a uniform depth over the entire surface of the burner. When the burner glass media is properly placed, it should look like the adjacent illustrations.
6. Note: If a few pieces of glass escape over the edges of the burner tray during installation, it is not a problem. They will simply land in the area below the burner and will do no harm.

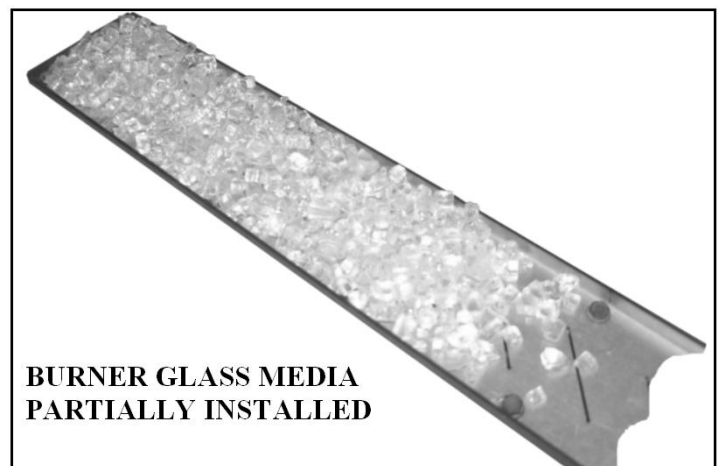
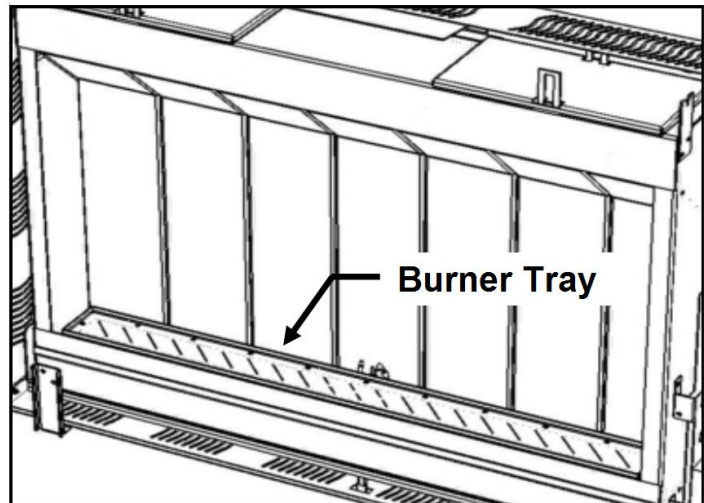

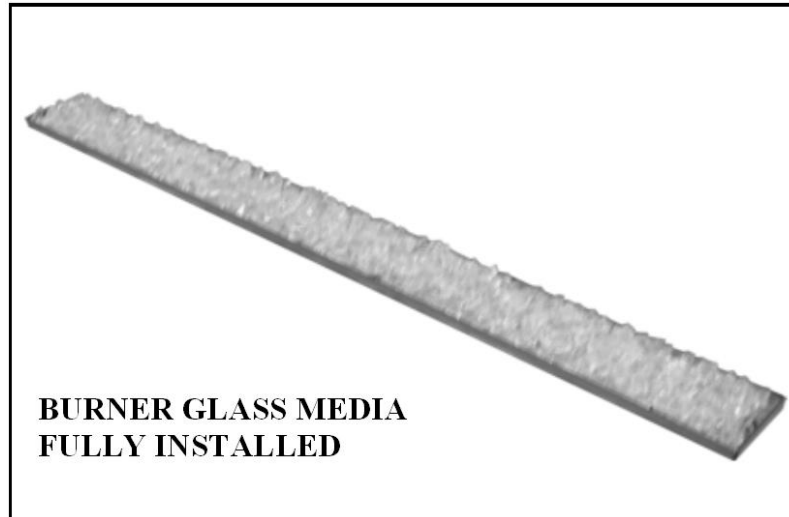

Relief Door Installation

1. The top relief doors are shipped separated from the fireplace and must be installed on the top of the firebox at this point in the installation. Note: The relief doors include a gasket that covers the full bottom surface. Use care in handling the relief door to avoid damage to the gasket material.
2. The first illustration below shows the relief openings and relief door retainers.
3. Each relief door includes line-up tabs that correspond to slotted retainers on the firebox.
4. Tip the relief door enough to allow the rear line-up tab to engage the rear retainer slot. Refer to the second illustration below.
5. Rotate the front edge of each relief door so they line-up over front retainers.
6. Gently spring the front forward so it will allow the relief door front line-up tab to engage on the retainer. Refer to the first illustration on the top of page 32.
7. The relief door should be able to move up and down freely on the retainers if properly installed.
8. When the relief door installation is complete, the doors should be in the full down position. Refer to the second illustration on page 32.

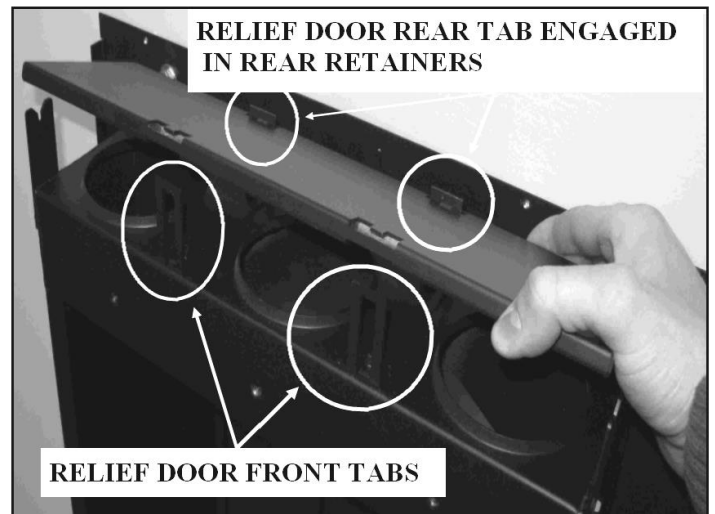
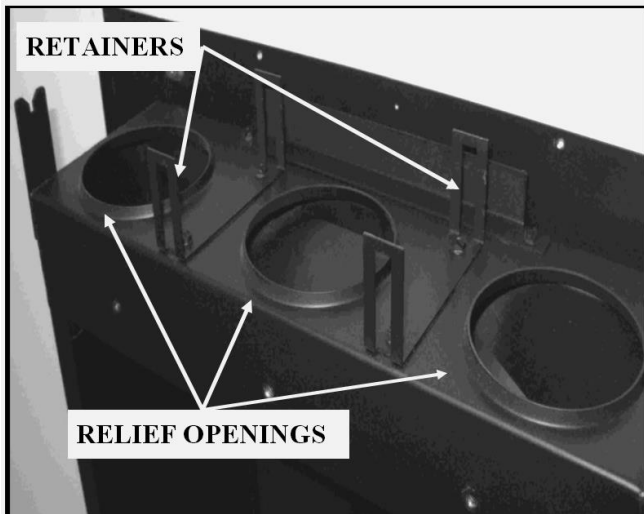

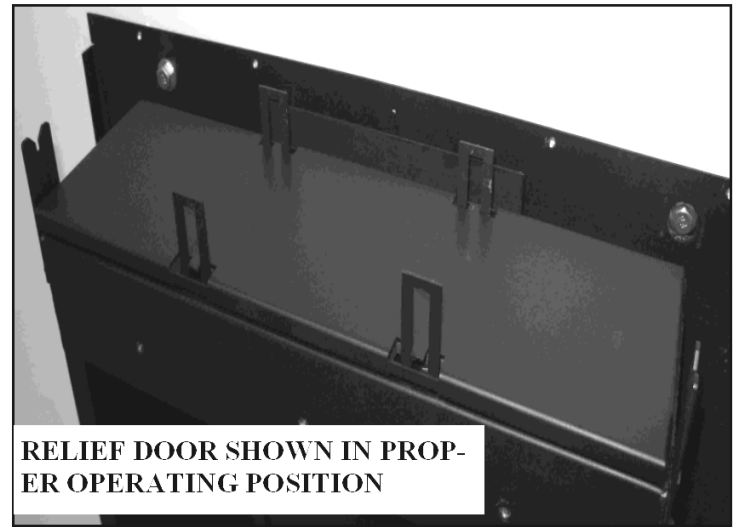
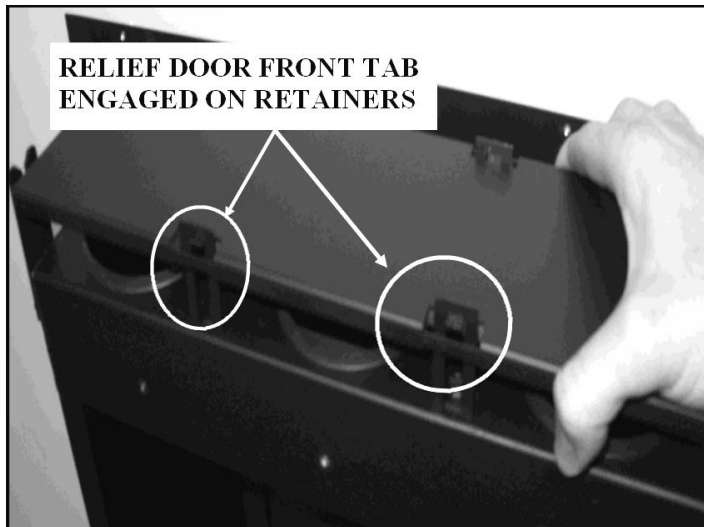

Installing the Front Glass Panel and Frame

After burner media and relief doors been installed, the next step is to replace the front glass panel and frame.

1. Carefully pick up the glass and glass frame assembly by grasping the sides of the frame and using your thumbs and fingers to hold the glass in place within the gasket and frame.
2. With the glass frame (and glass) held at a slight angle (leaving room for your fingers between the frame and the firebox) insert the bottom edge of the frame into the frame retainer located on the bottom front of the firebox. Take care to center the frame from left to right.
3. Once the bottom edge is in place, move your fingers out of the way and press the top of the frame against the firebox while pushing down to be sure the frame is fully engaged in the frame retainer.
4. Hold the frame in place with one hand and insert the four glass frame fasteners along the top edge of the glass frame. Tighten the fasteners until they are hand-tight.
5. Tighten each fastener 1/2 turn at a time, working from one side to the other, until the glass frame has made contact with the firebox face along the entire top edge. Do not over-tighten the fasteners as this can put excessive stress on the glass.
6. Draft relief openings must not be covered or blocked.

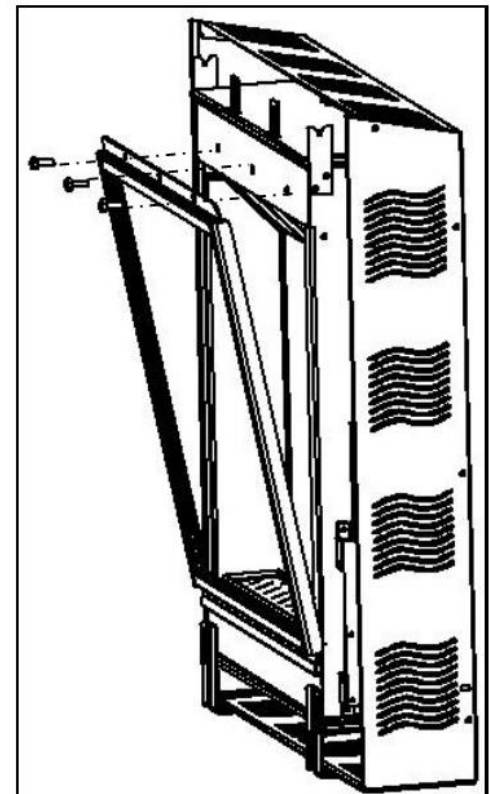

Installing the Outer Panels

1. The four outer decorative panels are secured to the fireplace with philips head screws. The top and bottom panels are secured to the fireplace mounting plate with sheet metal screws. All other screws are philips head machine screws.
2. Install the top panel first. Align the three holes along the rear edge of the panel with pilot holes along the top edge of the fireplace mounting plate.
3. Insert and tighten the three sheet metal screws. A magnetic nut driver is helpful.
4. Install the left side panel next. Align the three holes along the rear edge of the panel with the PEM nuts along the edge of the fireplace mounting plate. Insert the three philips head screws but do not fully tighten.
5. Locate the fastener hole at the top front edge of the left side panel and align with the PEM nut in the front of the top panel. Insert the philips head screw.
6. Make sure the edges of the panel are aligned with the edges of the top panel and mounting plate and tighten all four philips head screws.
7. Position the right side panel so it aligns with the three PEM nuts on the mounting plate and the front PEM nut on the top panel. Align the rear and top panel edges with the adjoining parts and insert and tighten the four philips head screws.
8. Install the bottom panel next. Guide the rear flange on the panel upward until the mounting holes in the flange line up with the pilot holes in the mounting plate.
9. Attach the panel to the mounting plate using sheet metal screws along the back edge of the panel. Note: It may make installation of the sheet metal screws easier if you remove the two lower surround mounting brackets from the front of the fireplace. A magnetic nut-driver will also be helpful.
10. Attach the bottom panel to the side panels by aligning the fastener holes in the bottom panel with the PEM nuts in the front corners of the bottom flanges on the side panels. Insert and tighten the two philips head screws.
11. Reinstall the lower surround brackets if you removed them by inserting and tightening the two sheet metal screws in each bracket.
12. Only trim kit(s) supplied by the manufacturer shall be used in the installation of this appliance.

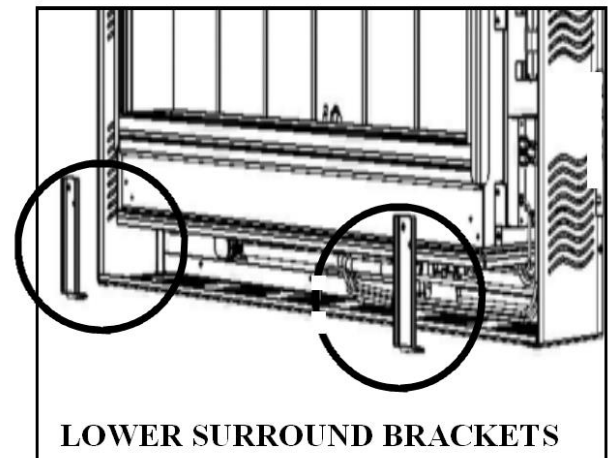
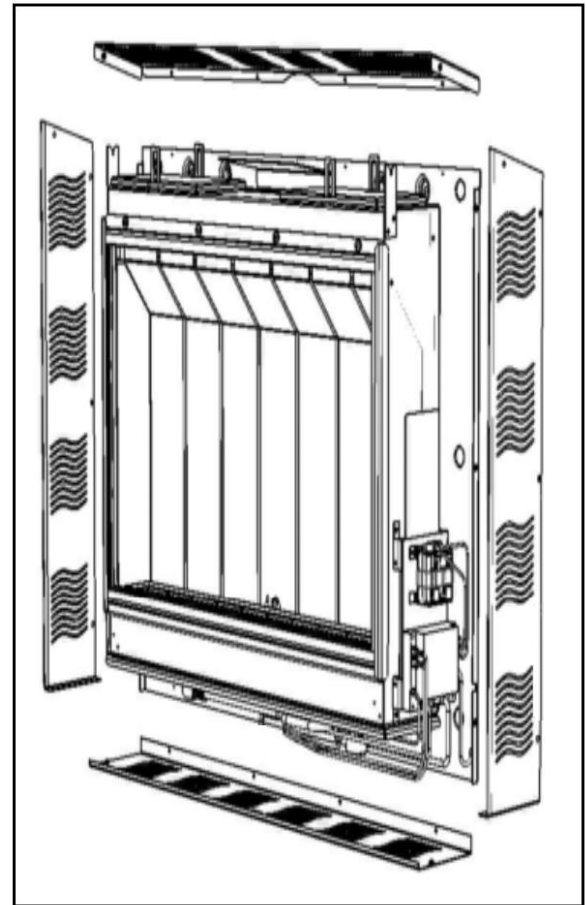

Installing the Fireplace Surround with Integrated Screen

The decorative surround with integrated screen for the fireplace is held in place by four brackets. Two are located on the top of the fireplace and two on the bottom. There are mating brackets and catch plates on the surround itself. Refer to the adjacent illustrations when installing the surround.

1. Unpack the surround with integrated screen from shipping box.
2. With a helper, lift the surround with integrated screen up and identify the top by looking for the vertical brackets that are visible from the rear of the surround.
3. Move the surround with integrated screen into place, generally centering the surround opening over the glass panel. Keep the bottom of the surround tipped slightly away from the fireplace.
4. While looking behind the surround with integrated screen, guide the two surround brackets onto the forward detent of the mating brackets on the fireplace top. You might find it easier to engage one bracket and then the other. Lower the surround until both bracket sets are fully mated.
5. Carefully push the top of the surround with integrated screen so that the surround brackets slide into the rear detent of the mating brackets on the fireplace top.
6. Carefully swing the bottom of the surround with integrated screen toward the base of the fireplace until the catch plates on the bottom flange of the surround are aligned with the spring loaded plungers on the bottom flanges of the lower surround mounting brackets.
7. To remove the surround with integrated screen, pull the bottom edge of the surround outward to disengage the spring loaded plungers and then lift the top up and off the upper brackets.
8. To prevent damage to the surround with integrated screen, always set the surround in a safe place while it is removed from the fireplace.

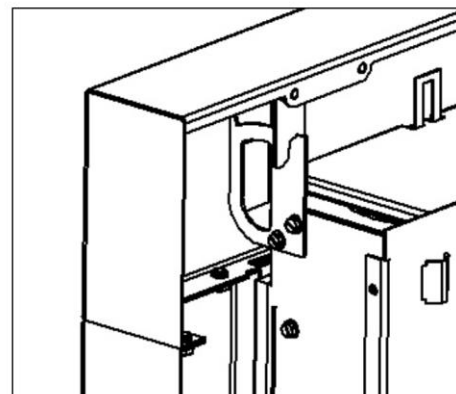
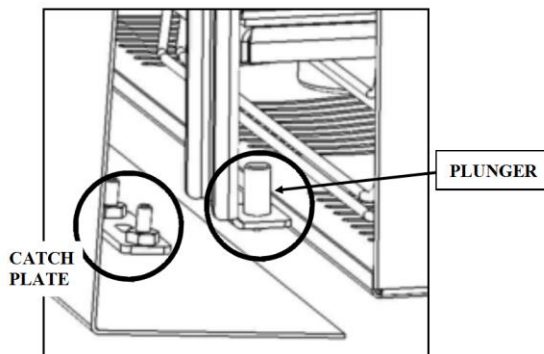
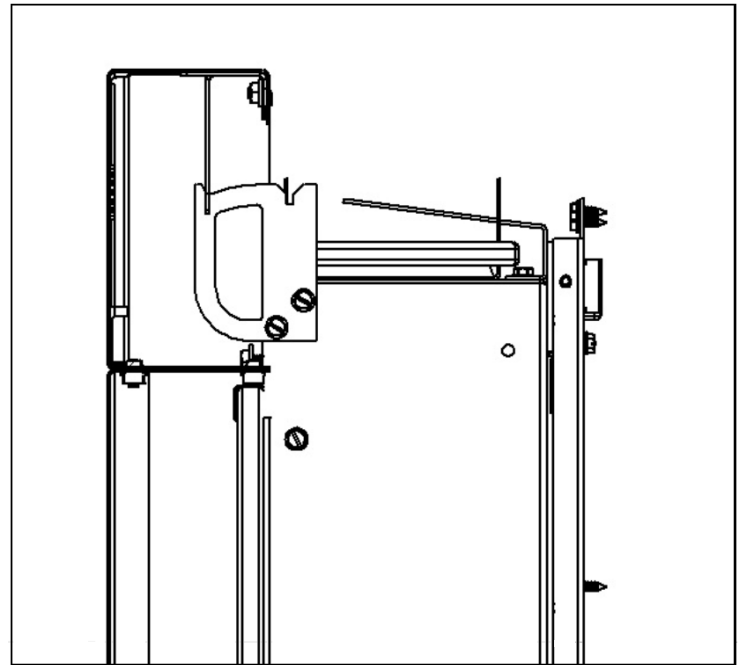

UPPER SURROUND BRACKETS
WHEN PROPERLY MATED

Lighting and Operation

FOR YOUR SAFETY READ BEFORE LIGHTING

WARNING: If you do not follow these instructions exactly, a fire or explosion may result causing property damage, personal injury or loss of life.



When lighting this appliance, follow these instructions exactly:

- A. This appliance is equipped with an ignition device that automatically lights the pilot. Do not try to light the pilot by hand.
- B. **BEFORE OPERATING THE BURNER SYSTEM**, smell around the appliance area for gas. Be sure to smell next to the floor because some gas is heavier than air and will settle on the floor.



WHAT TO DO IF YOU SMELL GAS

- 🔥 Do not try to light the appliance.
 - 🔥 Do not touch any electric switch; do not use any telephone in your building.
 - 🔥 Immediately call your gas supplier from a neighbor's telephone. Follow the gas supplier's instructions
 - 🔥 If you cannot reach your gas supplier, call the fire department.
- C. Use only your hand to operate the gas controls. Never use tools. If a knob will not push in or turn by hand, don't try to repair it, call a qualified service technician. Force or attempted repair may result in a fire or explosion.
 - D. Do not use this appliance if any part has been under water. Immediately call a qualified service technician to inspect the appliance and to replace any part of the control system which has been under water.

OPERATING INSTRUCTIONS

1. STOP! Read the safety information above on this label.
2. This appliance is equipped with an ignition device that automatically lights the pilot. Do not try to light the pilot by hand.
3. Using the Remote Handset, or the optional Wall Switch, push the "OFF"  button until you hear an audible signal to insure the appliance is Off.
4. Wait five (5) minutes to clear out any gas. Then smell for gas including near the floor. If you smell gas, STOP! Follow "B" in the safety information above. If you don't smell gas, proceed to step 5.
5. Using either the Remote Handset, or the optional Wall Switch, simultaneously press the "ON"  and "High Flame"  buttons. An audible signal confirms the start sequence has begun.
6. Continuing beeps confirm the ignition is in process. Once lighting the pilot flame should appear as shown in Fig.2. Once the pilot is confirmed, the main burner ignites on high.

NOTE: If the pilot does not stay lit after several tries, proceed to step 9.

7. Use the flame height adjustment buttons on either the Remote Handset or the optional Wall Switch to adjust the flame. Press the  button twice to decrease the flame height to its lowest setting, press the button twice to increase flame height to the highest setting. Pressing the  or  button once will module the flame to intermediate settings. The Remote Handset can also be used to control the appliance thermostatically.

8. Press and hold the  button on the Remote Handset or optional Wall Switch to set the appliance to Pilot flame only.
9. If the appliance will not operate, follow the instructions “TO TURN OFF GAS TO THE APPLIANCE” and call your gas service technician or gas supplier.

TO TURN OFF GAS TO THE APPLIANCE

1. To turn off gas to the appliance, push and release the  “OFF” button on either the Remote Handset or on the optional Wall Switch. You will hear an audible signal confirming the off setting.
2. TO TURN OFF THE GAS SUPPLY TO THE APPLIANCE, close the shut-off valve on the gas supply line to the appliance.

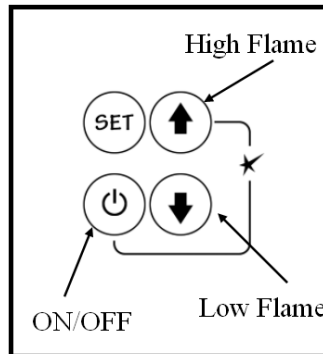

FIG. 1

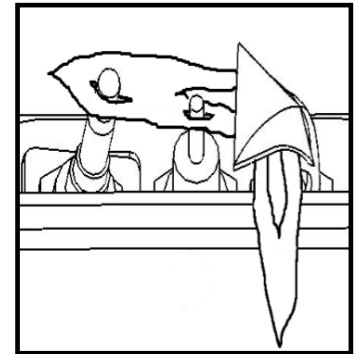

FIG. 2

OPERATING YOUR FIREPLACE FOR THE FIRST TIME

When operating your new fireplace for the first time, some vapors may be released due to the burning of curing compounds used in the manufacture of the appliance. They may cause a slight odor and could cause the flames to be the full height of the firebox, or even slightly higher, for the first few hours of operation.

It is also possible that these vapors could set off any smoke detection alarms in the immediate vicinity. These vapors are quite normal on new appliances. We recommend opening a window to vent the room. After a few hours use, the vapors will have disappeared and the flames will be at their normal height.

FLAME SUPERVISION DEVICE

For your safety, this appliance is fitted with a flame supervision device which will shut-off the gas supply if, for any reason, the pilot flame goes out. This device incorporates a fixed probe, which senses the heat from the pilot flame. If the probe is cool, the device will prevent any gas flow unless manually lighting the pilot. See full lighting instructions. Periodically check the pilot flame and compare to figure 2 above.

LIGHTING, OPERATION AND RATING INFORMATION

The Lighting, Operation and Rating information is located on a plate under the firebox.

To access the plate, remove any fret or access panel and grab the plate and slide it out to read it. There is important information on both sides of the plate.

WARNING

DO NOT ATTEMPT TO TOUCH THE DATA PLATE WHILE THE FIREPLACE IS STILL HOT!
Let the fireplace cool first before touching it.

SERVICING

If any attention is required for your appliance, contact your dealer quoting the model number. It will be helpful if the appliance's serial number can also be quoted. This number is on the rating plate, which is located under the burner. The replacement parts are shown at the end of this manual. Please always quote the part number and description when requesting spare parts.

FIREPLACE CONTROL DEVICES

There are two ways to control your fireplace.

1. Thermostatic Remote Control
2. Optional Wall Switch

The Thermostatic Remote Control can be programmed to function automatically—see pages 38-43.

The Wall Switch (optional) can be used to turn on, off and to increase or decrease the flame height.

NOTE: The remote control in the AUTO mode will override the optional wall switch.

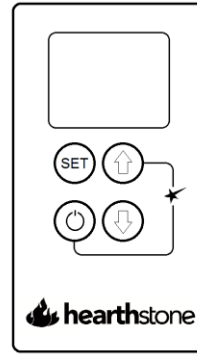

Programmable Thermostatic Remote Control

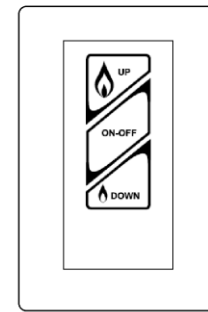

Optional Wall Switch

HOW TO TURN YOUR FIREPLACE OFF (INCLUDING PILOT)

Familiarize yourself with each of these methods before operating your fireplace.

Handset and Wall Switch: Press and hold the OFF button for a second (either on the handset or the wall switch).

If the flames are on, they go down and you hear the valve motor wind down. You hear a clunk and a beep indicating that the valve has received the signal from the remote control.

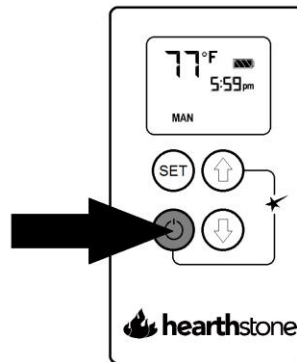

Programmable Thermostatic Remote Control

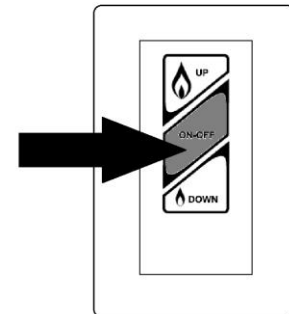

Optional Wall Switch

HOW TO ENSURE YOUR FIREPLACE CANNOT BE TURNED ON INADVERTENTLY

You can use the following method to ensure that your fireplace will not turn on when you don't want it on.

First, ensure your fireplace is turned off—including the pilot—and cold BEFORE going ahead.

- Close the shut-off valve on the gas supply line to the appliance.
- Remove all batteries from the receiver as well as the battery from the handset.

Automatic Shut-Off (in certain conditions)

Your fireplace's remote control is equipped with an automatic shut-off mechanism which is activated in certain conditions. See page 43 in the *Remote Control Operation* section for a description of this feature.

NOTE: Before using the remote control system for the first time, the receiver and the handset are synchronized at the factory. See the *Synchronizing the Remote and Valve Receiver Module* section under *Maintenance* on page 45 of this manual if the receiver and handset lose synchronization.

IMPORTANT: BEFORE YOU BEGIN, please note that on this system, the settings of time, temperature and automatic ON/OFF **can only be programmed when the function display is flashing.** Be patient when programming as it can take a few seconds to set.

Maxitrol Control System

Remote Control Layout

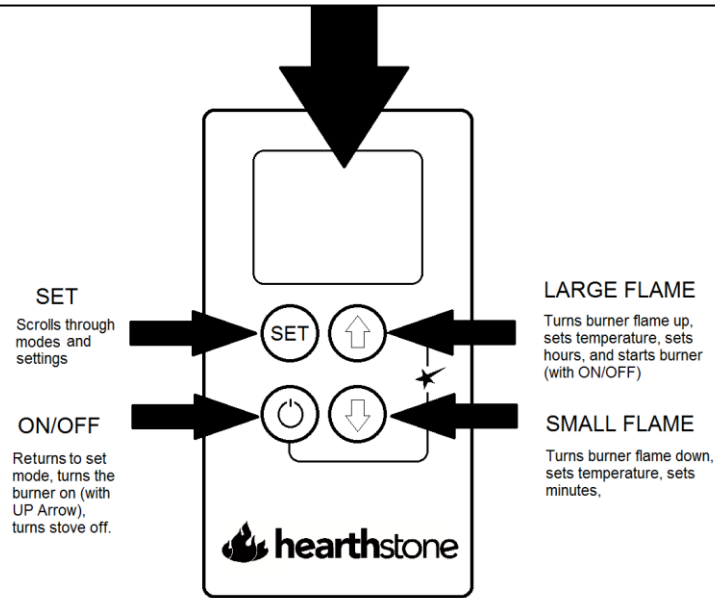
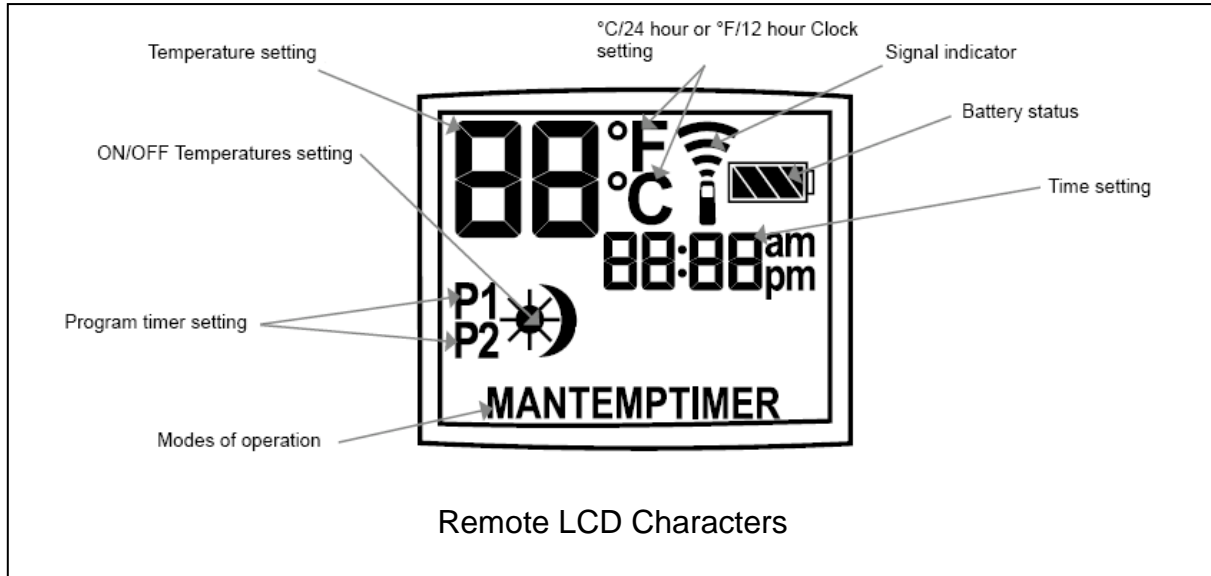

Handset Overview

Note: In the TEMP or TIMER modes, the remote handset senses the room temperature and adjusts the flame accordingly.

To communicate, the handset should be within 15 feet (4.5 meters) of the fireplace.

Do not leave the handset on the hearth, mantel, or on top of the fireplace.

BASIC REMOTE COMMANDS

TO TURN ON THE APPLIANCE

CAUTION

When pilot ignition is confirmed, motor turns automatically to maximum flame height.

- On the valve, turn MAN knob on the ON, full counterclockwise  position.

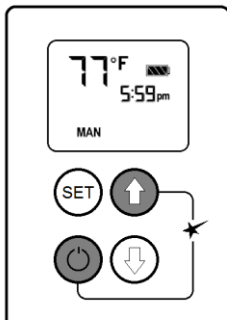

- Simultaneously press the OFF and  (large flame) buttons until a short beep confirms the start sequence has begun; release buttons.
- Continuing beeps confirm the ignition is in process.
- Once pilot ignition is confirmed, there is main gas flow.
- After main burner ignition the handset will automatically go into manual (MAN) control mode.

TO TURN OFF THE APPLIANCE

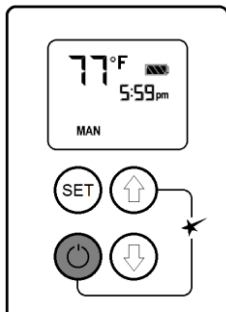



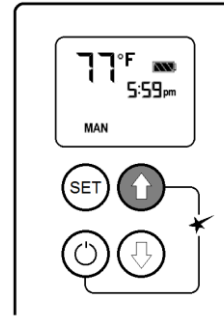

- Press OFF button.
- When the pilot is off, it will take 2 minutes before it can be lit again.

FLAME HEIGHT ADJUSTMENT

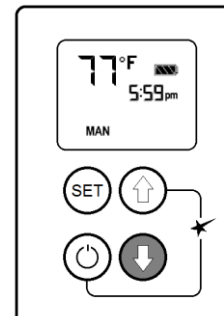



- In standby mode: Press and hold  (large flame) button to increase flame height.



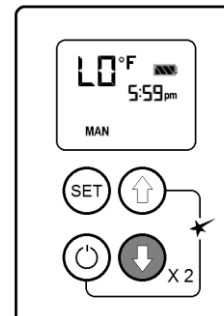

- Press and hold  (small flame) button to decrease flame height or to set the appliance at pilot flame.
- For fine adjustment tap the  (large flame) or  (small flame) buttons.

Express LO and HI Fire

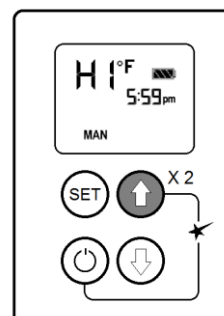

- Double-click  (small flame) button. "LO" will be displayed. NOTE: Flame goes to high fire first before going to designated low fire.



- Double-click  (large flame) button. Flame automatically goes to high fire. "HI" will be displayed.

SETTING C/24 HOUR OF F/12 HOUR

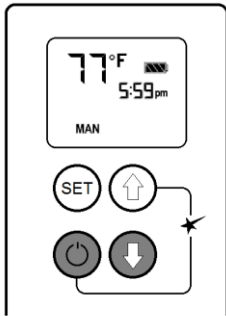

- In MAN mode, press OFF and (small flame) buttons until display changes from Fahrenheit/12-hour clock to Celsius/24-hour clock and vice versa.

SETTING THE TIME

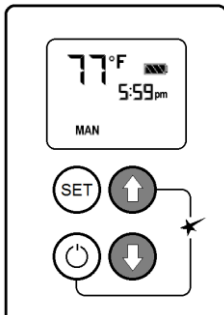

- The time display will flash after either: Installing the battery or simultaneously pressing the large flame (up arrow) and small flame (down arrow) buttons
- Press large flame (up arrow) button to set the hour.
- Press small flame (down arrow) button to set the minute.
- Press OFF or simply wait to return to MAN mode.

MODES OF OPERATION

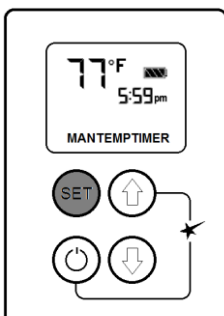

- Briefly pressing the SET button changes the mode of operation in the following order:

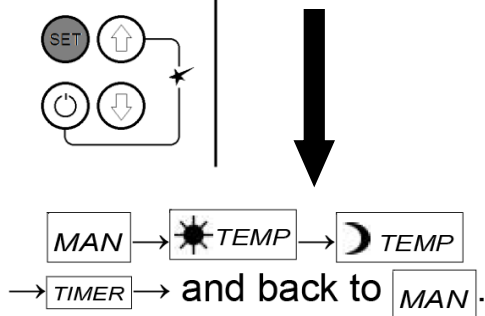

NOTE: Manual mode can also be reached by pressing either the (large flame) or the (small flame) buttons.

Whatever mode the remote is left in (MAN, TEMP, TIMER) is the mode the appliance will operate in until the mode is manually changed.

MANUAL MODE

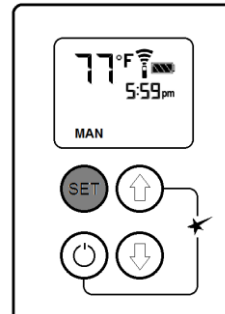

- In MAN mode, flame height is controlled by the up and down arrows. HO and LO commands function but otherwise is a “more or less flame” mode only.

DAYTIME TEMP MODE

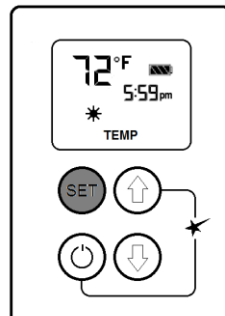

- (Appliance must be in standby mode; pilot ignited) - The room temperature is measured and compared to the set temperature. The flame height is then automatically adjusted to achieve the Daytime Set Temperature.

NIGHTTIME SETBACK TEMP MODE

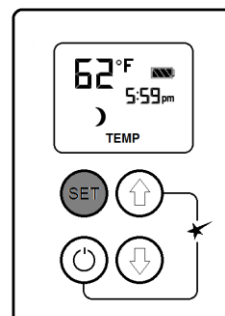

- (Appliance must be in standby mode; pilot ignited) - The room temperature is measured and compared to the set temperature. The flame height is then automatically adjusted to achieve the Nighttime Setback Temperature.

TIMER MODE

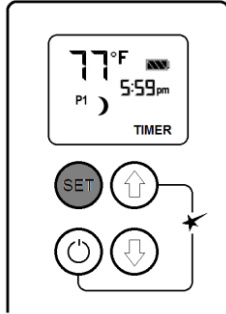

(Appliance must be in standby mode; pilot ignited)
The timers P1 and P2 (Program 1, Program 2) each can be programmed to go ON and OFF at specific times. For instructions see Timer Programming Mode.

NOTE: The display shows the set temperature every 30 seconds.

SETTING ON/OFF TEMPERATURES

SETTING THE “DAYTIME” TEMPERATURE

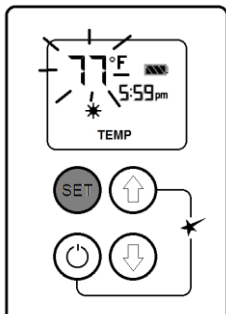

- Briefly press SET button to scroll to TEMP (sun) mode. Once there, hold the SET button down until the TEMP flashes.

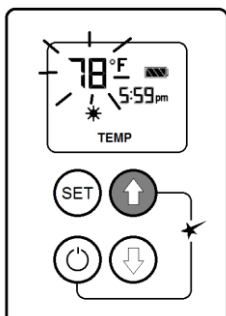

- Press (large flame) button to increase the Daytime Set Temperature or press (small flame) button to decrease Daytime Set Temperature.
- When finished, press OFF or wait for remote to re-set.

SETTING “NIGHTTIME SETBACK” TEMPERATURE

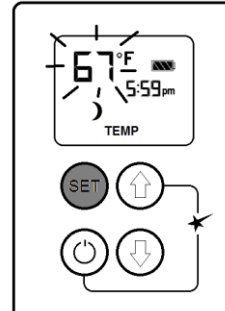

- Briefly press SET button to scroll to TEMP (moon) mode. Once there, hold the SET button until the TEMP flashes.

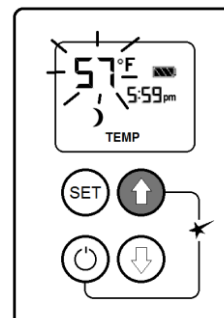

- Press (large flame) button to increase the Nighttime Set back Temperature or press (small flame) button to decrease Nighttime Setback Temperature.
- When finished, press OFF or wait for remote to re-set.

Tip

Set the different parameters only when they are flashing. For the Nighttime setback mode, pressing the down arrow until the LCD reads “- -” turns the Nighttime Setback Temp feature off.

SETTING PROGRAM TIMERS

Program timer mode allows the user to program a set time of day during which the appliance will operate to maintain a preset temperature (the Daytime Temp set above). When the appliance is not operating within this programmed time, it will revert to the Nighttime Setback Temp as programmed above.

Default settings:

Program 1: **P1** 6:00 am **P1** 8:00 am
Program 2: **P2** 11:50 pm **P2** 11:50 pm

Additional Information:

- 2 ON times can be programmed ☀ per day.
- C/24hr. mode: The day starts at 0:00, ends at 23:50.
- F/12hr. mode: The day starts at 12:00^{am}, ends at 11:50^{pm}.
- The ON/OFF times have to be programmed in the order P1 ☀ ≤ P1 🌙 < P2 ☀ ≤ P2 🌙.
- If P1 ☀ = P1 🌙 or P2 ☀ = P2 🌙 the timer is deactivated.
- To have the fire over night, it can be set:
 C/24hr. mode: P2 🌙 23:50 and P1 ☀ 0:00
 F/12hr. mode: P2 🌙 11:50^{am} and P1 ☀ 12:00^{am}

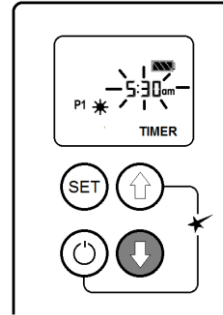

- Press the small flame arrow ↓ to set the minute.

Setting P1 On Time:

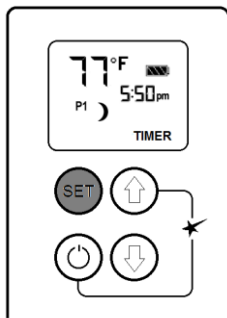

- Briefly press SET button to scroll to TIMER mode. P1 and the moon icon will also appear on the screen.

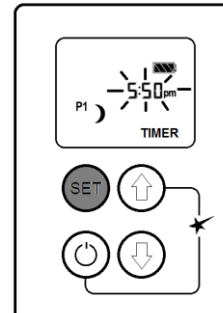

- Briefly press SET button to scroll to TIMER P1 mode (moon) while the time is still flashing.

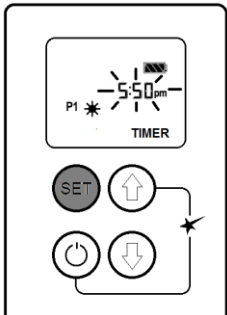

- Once there, hold the SET button down until the time of day flashes.

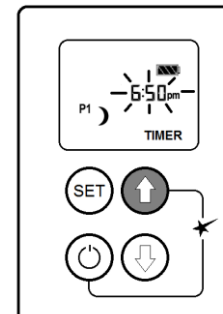

- Press the large flame arrow ↑ to set the hour.

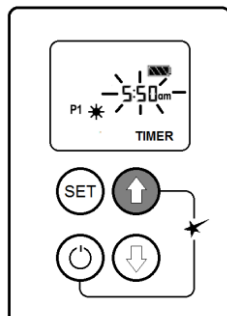

- Press the large flame arrow ↑ to set the hour.

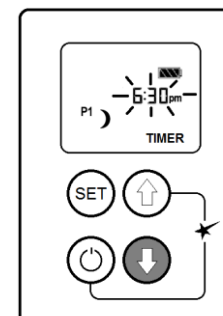

- Press the small flame arrow ↓ to set the minute.

Setting P2 On Time

- While the time of day is still flashing, briefly press SET to scroll to TIMER mode P2 ☀(sun).

- Follow the instructions given to set P1 ON time.

Setting P2 Off Time

- While the time of day is still flashing, briefly press SET to scroll to TIMER mode **P2** (moon).
- Follow the instructions given to set P1 OFF time.

Programming Example:

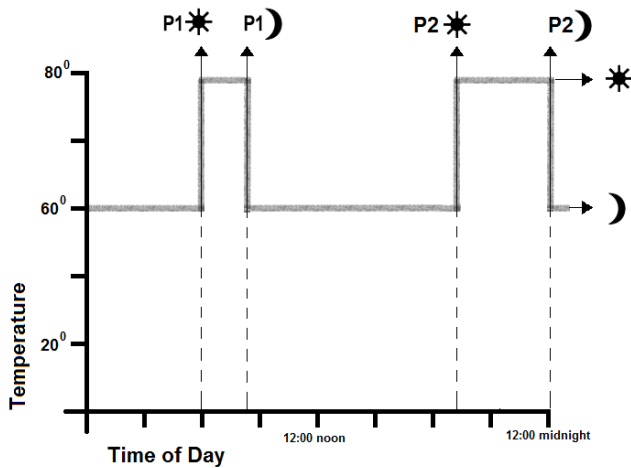

Appliance set to the following conditions will:

Increase temperature to 78 degrees from 6am to 8:45am each day, then return to 60 degrees until 7:30pm, at which time it will increase to 78 degrees until 12:00am, when it will return to 60 degrees and modulate there until 6:00am the following morning.

☀ Daytime temp set to 78°

☾ Nighttime temp set to 60°

P1☀ Program 1 daytime timer set to 6:00am

P1☾ Program 1 nighttime timer set to 8:45am

P2☀ Program 2 daytime timer set to 7:30pm

P2☾ Program 2 nighttime timer set to 12:00am

Tip

If you want to program only one period, program **P1** day and **P1** night with desired times and program **P2** day and **P2** night with the same time.

AUTOMATIC TURNDOWN

- No communication.** If there is no communication between the receiver and the

handset for a period of 6 hours, the appliance goes into pilot mode.

- No change in flame height.** If there is no change in flame height for a period of 6 hours, the appliance goes into pilot mode.

NOTE: In **TEMP** or **TIMER** modes, the flame height will vary according to room temperature. The appliance will continue to work normally. However, if the room temperature remains the same for 6 hours, the appliance will go into pilot mode.

AUTOMATIC SHUT OFF

- Low batteries in the receiver.** With low battery power in the receiver the system shuts off completely.

NOTE: This does not apply when the power supply is interrupted.

- No change in pilot.** The appliance shuts off completely when it is continually in pilot position— without any change—for a period of 5 days.

LOW BATTERY INDICATION

CAUTION

DO NOT USE a screwdriver or other metallic object to remove the batteries from the battery box or the handset! This could cause a short circuit.

- Remote handset:** The battery icon  will show when the battery needs to be replaced. Replace with one 3 “AAA” **alkaline** batteries.
- Receiver:** Three short ‘beeps’ will sound when the motor turns when the batteries need to be replaced. Replace with four 1.5 V **alkaline** batteries.
- HANDSET / RECEIVER MATCH**
The remote control handset and receiver are program- med to function together. In case of a replacement of the handset or the receiver, you will need to reset the receiver to allow them to function together. Contact your dealer for details.

Maintenance

A qualified service agency should conduct an annual inspection and maintenance of your ORION 46 including the overall installation and venting to keep it running safely. The following procedures should be performed only by a qualified service person. The gas supply should be turned off and the stove should be completely cool whenever a maintenance procedure is performed. All parts of the appliance that are removed for servicing must be replaced prior to operation.

WARNING: Do not operate the appliance with the glass front removed, cracked or broken. Replacement of the glass should be done by a licensed or qualified service person.

WARNING: Use only glass assembly, pt# 99-58205 which includes the glass panel, frame and gasket. Do not use substitute materials. Do not strike or slam the glass front. The appliance area must be kept clear and free from combustible materials, gasoline and other flammable vapors and liquids.

REPLACING THE GLASS

The glass mounting system consists of the glass panel, special glass gasket and the metal glass frame. Should the glass need to be replaced, you must replace the entire glass/glass frame pt# 99-58205. See page 49 for information on obtaining replacement parts. Use the following procedure and refer to the illustrations on page 32 of this manual.

1. Turn the fireplace completely off and allow it to cool to room temperature.
2. Remove the fireplace surround. See instructions on page 34.
3. If the glass is broken, be sure to wear gloves and eye protection.
4. Remove the glass frame fasteners from the top edge of the glass frame.
5. This will allow the glass frame to tip slightly forward. The glass may be loose in the frame, so it is very important to support both the glass and the frame when handling. Place your thumbs on the outside of the glass frame and wrap your fingers around the frame and onto the glass. Squeeze the frame and glass while moving. Carefully lift the glass frame and glass up and off the fireplace. Set the glass and frame aside on a padded surface. If the glass is broken, do this over spread out newspaper to catch all loose material. Wrap the old glass frame, glass and gasket in several layers of newspaper and discard.

Installing the replacement glass/glass frame assembly.

1. Unpack the new glass/glass frame assembly taking care when handling.
2. Carefully pick up the glass and glass frame assembly by grasping the sides of the frame and using your thumbs and fingers to hold the glass in place within the gasket and frame.
3. With the glass frame (and glass) at a slight angle (leaving room for your fingers between the frame and the firebox) insert the bottom edge of the frame into the frame retainer located on the bottom front of the firebox. Take care to center the frame from left to right. Once the bottom edge is in place, move your fingers out of the way and press the top of the frame against the firebox while pushing down to be sure the frame is fully engaged in the frame retainer. Hold the frame in place with one hand and reinstall the glass frame fasteners, leaving them loose.
4. Tighten the glass frame fasteners in stages working from the center out. Continue the process until all fasteners are uniformly tight. Do not over-tighten the fasteners.
5. Replace the fireplace surround. See instructions on page 34.

Cleaning the Glass

WARNING: Never clean the glass while it is hot. Do not use abrasive cleaners or cleaners containing ammonia.

NOTE: A micro-fiber cleaning cloth and plain water is recommended by the glass manufacturer.

Inspecting the Venting

An inspection of both the inner and outer vent pipes and the vent terminal should be made as part of the annual service appointment. The venting must have no blockage and be in good repair. The vent manufacturer's instructions may provide specific details on vent inspection. Any vent sections that are disassembled must be reassembled and sealed as required.

Any safety screen, guard, or barrier removed for servicing an appliance must be replaced prior to operating the appliance.

This appliance should be inspected before use and at least annually by a qualified service person. More frequent cleaning may be required due to excessive dust or lint from carpeting, bedding materials, pets, etc. It is imperative that control compartments and circulating air passageways of this appliance be kept clean.

Cleaning the Burner and Firebox

During the annual inspection and maintenance appointment, the service person should clean the burner and firebox. To gain access to the firebox and burner, follow the instructions beginning on page 32 of this manual. **DO NOT USE A VACUUM CLEANER TO CLEAN THE GLASS BURNER MEDIA.**

A vacuum cleaner may be used to clean the metal parts of the firebox. Leave the glass burner media in place. Use a soft brush to clean the burner glass media. If the burner media does need to be removed, carefully scoop it off the burner and avoid dropping glass pieces in the air gaps around the burner. Follow the instructions on page 30 of this manual when replacing the burner media on the burner top.

Air Flow

The ORION 46 utilizes a convection air heat exchange system to maximize heat delivered from the fireplace. It is important that air flows freely through the convection air system and out the top and side air grills. Do not place objects under the fireplace that will block the convection air inlet flow or in front of any air outlet.

Synchronizing the Remote and Valve Receiver Module

A code is selected automatically for all Mertik Maxitrol electronics from among 65,000 random codes available. The receiver must learn the code of the handset, which is performed at the factory. If for any reason your appliance stops responding to remote commands, it may be necessary to re-sync the two components. To access the Valve Receiver Module, follow the instruction on pages 32-34. Once you have access to the Receiver, press and hold the receiver's reset button (*see figure below*) until you hear two (2) beeps. The first beep is short and the second beep is long. After the second beep, release the reset button. Within 20 seconds

press the Small Flame button on the handset until you hear two additional short beeps confirming the code is set. If you hear one long beep, this indicates the code has failed or the wiring is incorrect.



Step 1: Locate Reset Button on Receiver



Step 2: Press and hold Reset button until second beep is finished

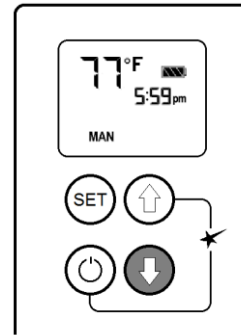

Step 3: Within 20 seconds, press Small Flame button on the remote

Maintenance Log

We strongly recommend that you keep a log of the regular maintenance that is performed on your fireplace. We have provided the forms below to make it easy. Simply ask your qualified service person to fill out one of the maintenance record forms below, each time the fireplace is serviced. This will help insure that all of the required maintenance procedures have been completed, at least annually. Regular maintenance will help keep the fireplace functioning in a safe and reliable manner. Additional forms are available from your installer or service person when needed.

Date of Service _____
 Serviced By _____

Service Performed

- Inspect Venting
- Clean Burner & Firebox
- Clean Control Area
- Clean Convection Air System
- Leak Test Gas Connections
- Other _____

Date of Service _____
 Serviced By _____

Service Performed

- Inspect Venting
- Clean Burner & Firebox
- Clean Control Area
- Clean Convection Air System
- Leak Test Gas Connections
- Other _____

Date of Service _____
 Serviced By _____

Service Performed

- Inspect Venting
- Clean Burner & Firebox
- Clean Control Area
- Clean Convection Air System
- Leak Test Gas Connections
- Other _____

Date of Service _____
 Serviced By _____

Service Performed

- Inspect Venting
- Clean Burner & Firebox
- Clean Control Area
- Clean Convection Air System
- Leak Test Gas Connections
- Other _____

Date of Service _____
 Serviced By _____

Service Performed

- Inspect Venting
- Clean Burner & Firebox
- Clean Control Area
- Clean Convection Air System
- Leak Test Gas Connections
- Other _____

Date of Service _____
 Serviced By _____

Service Performed

- Inspect Venting
- Clean Burner & Firebox
- Clean Control Area
- Clean Convection Air System
- Leak Test Gas Connections
- Other _____

Installation Record

The installer should complete the form below that describes the details of the installation. Having this written record of installation information available will greatly expedite trouble-shooting should any problem arise with your stove. The installer should keep a duplicate of this form for their records.

DATE PURCHASED:	<input style="width: 100%;" type="text"/>																						
DEALER:	<input style="width: 100%;" type="text"/>																						
INSTALLER:	<input style="width: 100%;" type="text"/>																						
FIREPLACE S/N:	<input style="width: 100%;" type="text"/>																						
DATE INSTALLED:	<input style="width: 20%;" type="text"/>	<input style="width: 30%;" type="text"/>																					
FUEL:	<input type="checkbox"/> NAT. GAS	<input type="checkbox"/> LP GAS																					
INLET PRESSURE MEASURED AFTER INSTALLATION:	<input style="width: 50px;" type="text"/>	IN. WC																					
MANIFOLD PRESSURE MEASURED AFTER INSTALLATION:																							
	HIGH FIRE:	<input style="width: 50px;" type="text"/> IN. WC																					
	LOW FIRE:	<input style="width: 50px;" type="text"/> IN. WC																					
VENTING:																							
<u>VENT BRAND:</u>																							
Simpson DuraVent GS/Pro®	<input type="checkbox"/>	Selkirk Direct-Temp® <input type="checkbox"/>																					
AmeriVent Direct™	<input type="checkbox"/>	Security Secure Vent™ <input type="checkbox"/>																					
		Metal Fab Direct Vent <input type="checkbox"/>																					
		ICC EXCELDirect <input type="checkbox"/>																					
VENT TERMINATION (CAP):	HORIZONTAL <input type="checkbox"/>	VERTICAL <input type="checkbox"/>																					
		SNORKEL <input type="checkbox"/>																					
VENT CAP MODEL NO:	<input style="width: 150px;" type="text"/>																						
<u>CONFIGURATION</u>																							
TOTAL HORIZONTAL RUN:	<input style="width: 100px;" type="text"/>	FEET/INCHES																					
TOTAL VERTICAL RISE:	<input style="width: 100px;" type="text"/>	FEET/INCHES																					
QTY. 90° ELBOWS:	<input style="width: 100px;" type="text"/>																						
QTY. 45° ELBOWS:	<input style="width: 100px;" type="text"/>																						
ALTITUDE:	<input style="width: 100px;" type="text"/>	FEET ABOVE SEA LEVEL																					
WAS STOVE DERATED?	<input style="width: 100px;" type="text"/>	Y or N? IF YES, TO WHAT ORIFICE SIZE? <input style="width: 50px;" type="text"/>																					
UNUSUAL STRUCTURE NEAR VENT TERMINATION - DESCRIBE:	<table border="1" style="width: 100%; border-collapse: collapse;"> <thead> <tr> <th style="width: 33%;">INSIDE CORNER</th> <th style="width: 33%;">TREES/SHRUBS</th> <th style="width: 33%;">OTHER</th> </tr> </thead> <tbody> <tr><td style="height: 20px;"> </td><td> </td><td> </td></tr> <tr><td style="height: 20px;"> </td><td> </td><td> </td></tr> <tr><td style="height: 20px;"> </td><td> </td><td> </td></tr> <tr><td style="height: 20px;"> </td><td> </td><td> </td></tr> <tr><td style="height: 20px;"> </td><td> </td><td> </td></tr> <tr><td style="height: 20px;"> </td><td> </td><td> </td></tr> </tbody> </table>		INSIDE CORNER	TREES/SHRUBS	OTHER																		
INSIDE CORNER	TREES/SHRUBS	OTHER																					
PREVALENT WIND CONDITIONS?																							
OTHER INSTALLATION NOTES:																							

Replacement Parts List

PART NAME	P/N	PART NAME	P/N
Pilot Head NG/LP	7211-070	Burner Orifice (NG)	7200-212
Pilot Thermocouple*	7211-473	Burner Orifice (LP)	7200-213
Pilot Injector (NG)	7211-071	Burner Glass Media – Clear	7211-762
Pilot Injector (LP)	7211-072	Burner Module (NG)	99-74200
Receiver Module (Maxitrol)	7000-381	Burner Module (LP)	99-74201
Wall Switch Panel (optional)	7000-260	Firebox Panel – Rear	99-76201
Remote Handset (Maxitrol)	7000-362	Firebox Panel – Left	99-76202
Gas Valve (Maxitrol)	7211-308	Firebox Panel – Right	99-76203
TC Line Red	7000-069	Thermocouple Interrupter Block	7000-067
TC Line Yellow	7000-044	8-Wire Connecting Cable	7000-044
		Glass Assy (including gasket & frame)	99-58205

***This is a quick response thermocouple. Replace it only with Hearthstone Part Number 7211-473**

For replacement parts and customer service, contact your Aurora dealer or:

Hearthstone Quality Home Heating Products, Inc.
 Technical Services
 317 Stafford Avenue
 Morrisville, VT 05661
www.hearthstonestoves.com

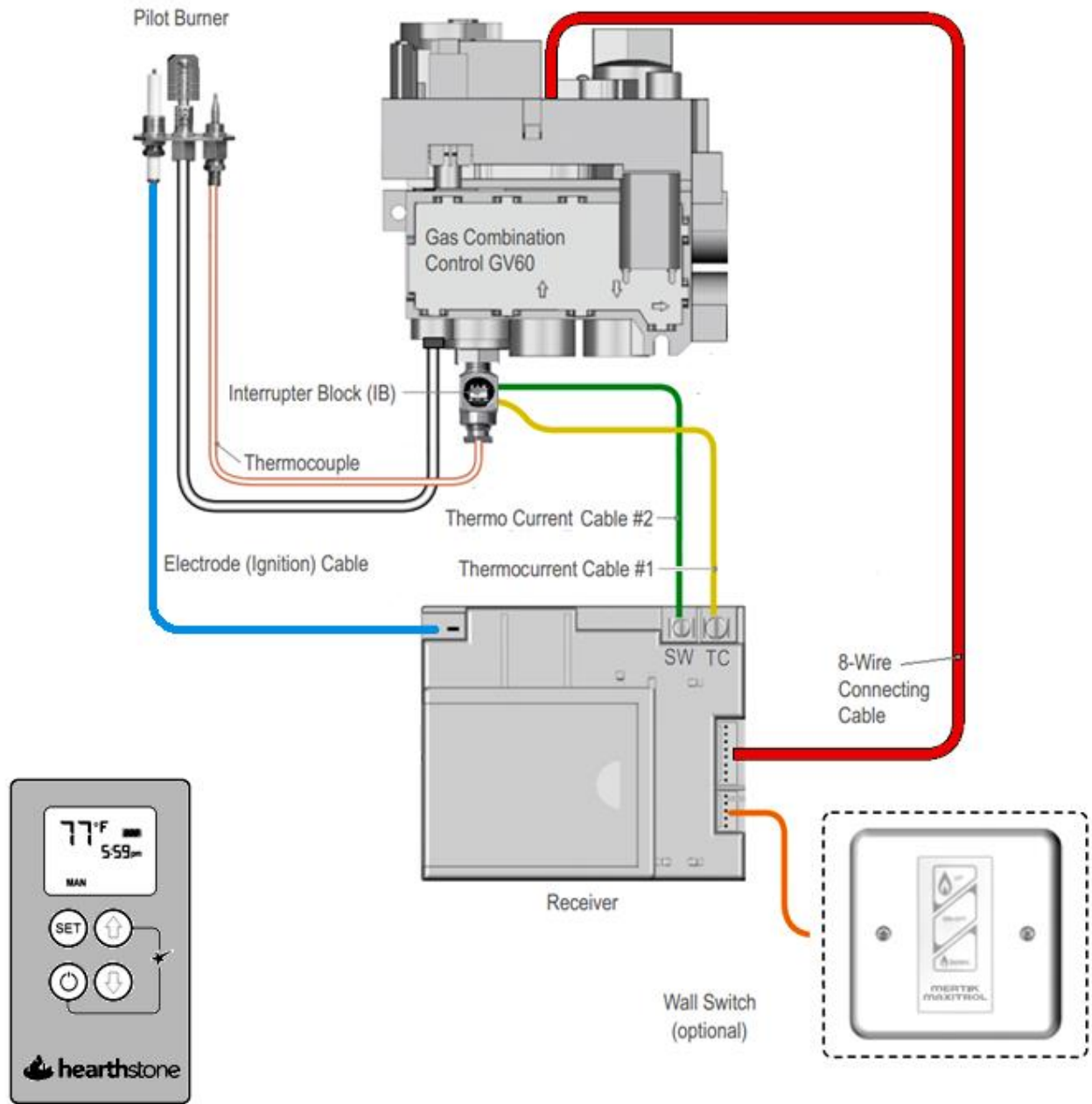

Maxitrol GV-60 Control System

Troubleshooting

Symptom	Possible Cause	Corrective Action
1. Pilot will not light.	<p>A. Optional Power supply not plugged in and/or batteries are dead.</p> <p>B. Insufficient gas pressure, air in the pilot line, or dirty or kinked gas line.</p> <p>C. Pilot orifice plugged.</p> <p>D. Defective or misaligned igniter element in pilot assembly.</p> <p>E. Defective igniter.</p> <p>F. After sitting for "off" season (summer), pilot assembly may be dirty.</p>	<p>A. Ensure power supply is plugged in and receiving 120V AC. Replace all batteries with known good batteries.</p> <p>B. Allow time for system to purge air in line. Check the inlet gas pressure. Make sure it is within the Min/Max. allowable pressures.</p> <p>C. Clean or replace the pilot assembly.</p> <p>D. If a flame lights the pilot, check the electrode gap and location. The gap should be 1/8" in the flame area.</p> <p>E. Check for a good connection between igniter and electrode. Check wire insulation. If everything is properly connected and still no spark, replace the Ignition Module.</p> <p>F. Clean or replace the pilot assembly.</p>
2. Pilot in Manual or Standby mode and will not stay lit after carefully following lighting instructions.	<p>A. Low or too high gas pressure</p> <p>B. Faulty connections.</p> <p>C. Pilot dirty or plugged.</p> <p>D. Thermocouple damaged.</p> <p>E. Thermocouple Interrupter circuit damaged.</p>	<p>A. Check for proper inlet pressure for the fuel gas in use.</p> <p>B. Check connections on the valve.</p> <p>C. Clean or replace the pilot assembly.</p> <p>D. Check for appropriate MV at thermocouple interrupter.</p> <p>E. Check thermocouple interrupter circuit for damage or loose connections.</p>
3. Pilot burning, no gas to main burner.	<p>A. Gas control system may be damaged.</p> <p>B. No power and/or batteries may be dead.</p> <p>C. Plugged burner orifice.</p>	<p>A. Check wiring for proper connections. Check components for proper operation. Check for appropriate MV output from thermocouple and check connections at thermocouple interrupter.</p> <p>B. Restore 120V service or replace batteries in receiver.</p> <p>C. Inspect burner.</p>
4. Pilot and burner come on, but go out after some warm-up.	<p>A. Inconsistent draft.</p> <p>B. Insufficient gas pressure.</p> <p>C. Excessive draft.</p>	<p>A. Check flue for blockage or other damage to venting.</p> <p>B. Check line pressure to ensure that the correct inlet pressure is present for the type of gas being used. If propane pressure is inconsistent, check for water condensation at the regulator.</p> <p>C. Check Restriction settings per this manual.</p>

Symptom	Possible Cause	Corrective Action
5. Frequent pilot outage.	A. Pilot flame may be too low or blowing, (high), causing the pilot safety to drop out. B. Excessive draft	A. Clean and/or adjust the pilot flame for maximum impingement on the thermocouple. B. Check Restriction settings per this manual.
6. Glass fogs	A. A normal result of gas combustion in a cold stove.	A1. After the heater has warmed up, the glass should clear. A2. Leave pilot in standby mode to keep stove warmer.
7. Blue Flames	A. A normal result during the first 20 minutes.	A. Flames should begin to turn more yellowish after 20 minutes of burning. B. If the blue color stays; adjust the air shutter for a proper burn.
8. Floating flames, lazy ill-defined, quiet flames, which roll around, sometimes completely off of the port, sometimes with overly, yellow tips. Possible sooting. Usually accompanied by the odor of aldehydes.	A. Potentially dangerous incomplete combustion due to incorrect air to fuel ratio (lack of combustion air or excessive fuel delivery I.e. excessive gas pressure, overrating of appliance). B. Incorrect air intake/exhaust flow system. Causes may be: B1. Blocked burner. B2. Blocked primary air B3. Blocked secondary air inlets C. Incorrect vent restrictor setting.	A. Check the appliance input rate and reduce if necessary. The air intake/exhaust flow system may be too restrictive or blocked (the rate at which the exhaust leaves [draft] determines the rate at which the combustion air is delivered). Poor draft results in insufficient air delivery or a restricted exhaust. Correct air intake/exhaust flow system. B1. Clear ports. B2. Clear obstructions. B3. Clear obstructions. C. If gas pressures are correct and the flames stay the same, check vent restrictor settings for a proper burn.
9. Burner flashback. Air-gas mixture ignites inside the burner near the orifice, usually creating a roaring noise like a blowtorch. The problem is an imbalance of gas flow velocity and burning speed pattern.	A. Excessive primary air. B. Burner input underrated. C. Valve leak if flashback occurs with burner valve in off position. D. Improper gas pipe size.	A. Adjust the air shutter for a proper burn. B. Check input rate. Check input pressure using a manometer. Confirm correct gas pressure at house meter or tank (call gas company). Confirm burner orifice size. C. Replace valve. If above corrections do not eliminate flashback, replace burner. D. Correct plumbing.
10. Delayed ignition (makes a sudden "whoosh" noise as the burner lights). This is a buildup of gas prior to ignition. This is more prevalent with propane (LP) fuel.	A. Incorrect air-to-fuel ratio. A1. Primary air incorrect. A2. Burner ports plugged.	A1. Adjust the air shutter for a proper burn. A2. Open ports to allow for proper travel of flames. B. Reposition media to eliminate interference with flame travel.

Limited Warranty

These warranties give you specific legal rights. You may also have other rights which vary from State to State.

Hearthstone Quality Home Heating Products, Inc. (Hearthstone) warrants to the original retail purchaser only (the "Original Purchaser") the new appliance manufactured by Hearthstone, purchased by the Original Purchaser and installed by an authorized Hearthstone dealer or their designated representative against any of the occurrences listed in this document that result from defects in material or workmanship. This warranty is not transferrable. All obligations of Hearthstone under this document commence on the date of the Original Invoice (the "Purchase Date"). The term "Limited Lifetime" is defined as 10 years from the beginning of warranty coverage.

Hearthstone appliances are designed to be operated only with the fuels listed in your owner's manual.

Burner – Repair or replacement for three years from date of installation.

Gas components & electrical components – Repair or replacement for one year from date of installation.

Blowers & remote controls – Repair or replacement for one year from the date of installation.

Porcelain Firebox Liners – Replacement for one year against cracking or breakage due to thermal stress from date of installation. Excludes surface and hairline cracks and scratches or slight color changes that do not affect the operation or safety of the unit.

Gaskets – Repair or replacement for one year from the date of installation.

Surrounds – Replacement for one year against cracking or breakage due to thermal stress. Excludes surface and hairline cracks and scratches or slight color changes that do not affect the operation or safety of the unit.

Any parts repaired or replaced during the limited warranty period will be warranted under the terms of the limited warranty for a period not to exceed the remaining term of the original limited warranty or one year, whichever is longer.

Parts: Hearthstone will replace through an authorized dealer, defective parts covered by the foregoing warranty at no charge.

Labor: Within the first (1st) year after the Purchase Date, Hearthstone will pay for warranty labor performed by an authorized Dealer at Hearthstone's published labor rates in effect at the time the labor is performed only if the appliance is installed by an authorized dealer or their designated representative. Otherwise or thereafter, the Original Purchaser is responsible for the cost of labor.

Shipping cost for parts: Within the first ninety (90) days after the Purchase Date, Hearthstone will pay for the shipping of appliance parts covered by any of the foregoing warranties to and from Hearthstone or an authorized Dealer, as the case may be. Thereafter, the Original Purchaser is responsible for all shipping costs related to shipping appliance parts to and from Hearthstone or an authorized Dealer, as the case may be.

Shipping cost for the appliance: Within the first (1st) year after the Purchase Date, if the Original Purchaser is instructed to return the appliance to Hearthstone or an authorized Dealer for repair, Hearthstone will pay fifty percent (50%) and the Original Purchaser will pay fifty percent (50%) of the shipping costs related to shipping the appliance to and from Hearthstone or an authorized Dealer, as the case may be. Thereafter, the Original Purchaser is responsible for one hundred percent (100%) of all of the shipping costs related to shipping the appliance to and from Hearthstone or an authorized Dealer, as the case may be. Notwithstanding any other provision of this document, in no event will Hearthstone pay

for any Dealer fees or other fees for pick up or delivery of the appliance returned for repair; the Original Purchaser shall be responsible for any such fees.

EXCLUSIONS & CONDITIONS

The warranties contained in this document do not cover, nor is Hearthstone responsible for:

1. Damages resulting from:
 - a. Failure to install, operate, or maintain the appliance in accordance with the owner's manual, operating instructions, installation instructions, or safety rating label provided with the appliance.
 - b. Over-firing the appliance. Over-firing can be identified by, but not limited to, warped cast iron or steel, rust colored cast iron, bubbling, cracking and discoloration of steel or enamel finishes.
 - c. Failure to install the appliance in accordance with all national or local building codes.
 - d. Shipping or improper handling.
 - e. Improper operation, abuse, misuse, continued operation with damaged, corroded, or failed components, accident, or improper/incorrect service or repairs.
 - f. Environmental conditions, inadequate ventilation, negative pressure, or improper drafting caused by tightly sealed constructions, insufficient make-up air supply, or air handling devices such as exhaust fans, forced air furnaces, or other such causes.
 - g. Damage caused by direct exposure to water.
 - h. Use of fuels other than those specified in the owner's manual.
 - i. Installation or use of components not supplied with the appliance, or any other components not expressly authorized and approved by Hearthstone.
 - j. Modifications of the appliance not expressly authorized and approved by Hearthstone in writing
 - k. Interruptions or fluctuations of electrical power supplied to the appliance.
2. All stones are warranted against cracking or breakage due to thermal stress, excluding surface and hairline cracks and scratches that do not affect the operation, or safety of the appliance.
3. Repair or replacement of wear parts. Such parts that are subject to normal wear and tear during the warranty period such as paint, gaskets, baffles, refractory materials, ash grates, and glass.
4. Damage resulting from installation, modification, alteration, repair or service of the appliance by any party other than an authorized Hearthstone dealer (a "Dealer") or their designated representative, or Hearthstone.
5. Damage due to water or condensation due to installation of the appliance in a high moisture area.
6. Damage due to installation of the appliance in an atmosphere contaminated by damaging chemicals, including but not limited to chlorine, fluorine or salts.
7. Scratches on glass, enameled surfaces or stones due to mechanical abrasion.
8. Noise caused by expansion or contraction caused by the heating and cooling of the appliance.
9. Odors caused by the heating of the appliance, or surrounding materials
10. Consequential damage caused by leaking of condensate during startup
11. A defect in any part of the appliance if the Original Purchaser fails to comply with Hearthstone's or a Dealer's request to ship the part or the appliance to Hearthstone or a Dealer, as the case may be.
12. Replacement stones and enameled parts are taken from current stock, and may not match originals in color, grain, or pattern. Hearthstone will supply replacement parts for discontinued parts in finishes or colors as available, or at their discretion.
13. Hearthstone's obligation under this warranty does not extend to the appliance's ability to heat the desired space. Information is provided to assist the customer and the dealer in selecting the appropriate appliance for the application. Consideration must be given to appliance location and configuration, environmental conditions, insulation and air tightness of the structure.

THE WARRANTIES CONTAINED IN THIS DOCUMENT ARE EXCLUSIVE AND ARE GIVEN BY HEARTHSTONE AND ACCEPTED BY THE ORIGINAL PURCHASER IN LIEU OF ALL OTHER EXPRESS WARRANTIES AND ANY OBLIGATIONS, LIABILITIES, RIGHTS, CLAIMS, OR REMEDIES IN CONTRACT OR TORT, WHETHER OR NOT ARISING FROM HEARTHSTONE'S NEGLIGENCE, ACTUAL OR IMPUTED. ALL IMPLIED WARRANTIES, INCLUDING THE WARRANTIES OF MERCHANTABILITY AND FITNESS FOR A PARTICULAR PURPOSE, ARE GIVEN ONLY TO THE EXTENT REQUIRED BY FEDERAL OR STATE LAW. EXCEPT AS OTHERWISE REQUIRED BY STATE LAW, UPON THE EXPIRATION OF THE EXPRESS LIMITED WARRANTIES CONTAINED

HEREIN, NO IMPLIED WARRANTIES, INCLUDING THE IMPLIED WARRANTIES OF MERCHANTABILITY OR FITNESS FOR A PARTICULAR PURPOSE, SHALL APPLY TO THE SUBJECT APPLIANCE. SOME STATES DO NOT ALLOW LIMITATIONS ON HOW LONG AN IMPLIED WARRANTY LASTS, SO THE ABOVE LIMITATION MAY NOT APPLY TO YOU.

THE WARRANTIES CONTAINED IN THIS DOCUMENT EXTEND ONLY TO THE ORIGINAL PURCHASER OF THE APPLIANCE WARRANTED HEREUNDER. THEY ARE NOT TRANSFERRABLE AND DO NOT EXTEND TO ANY SUBSEQUENT OWNERS.

UNDER NO CIRCUMSTANCES SHALL HEARTHSTONE BE LIABLE TO THE ORIGINAL PURCHASER OR ANY OTHER PERSON FOR ANY INCIDENTAL OR CONSEQUENTIAL DAMAGES, INCLUDING BUT NOT LIMITED TO DAMAGE TO PROPERTY OR PERSONAL INJURIES, WHETHER ARISING OUT OF LOSS OF USE, BREACH OF WARRANTY, TORT, OR OTHERWISE, EVEN IF HEARTHSTONE HAS BEEN APPRAISED OF THE POSSIBILITY OF SUCH DAMAGES. SOME STATES DO NOT ALLOW THE EXCLUSION OR LIMITATION OF INCIDENTAL OR CONSEQUENTIAL DAMAGES, SO THE ABOVE LIMITATION OR EXCLUSION MAY NOT APPLY TO YOU.

QUALIFYING FOR WARRANTY COVERAGE

To obtain performance of any obligation under this document, the Original Purchaser must, within the applicable warranty time period, contact their original Hearthstone dealer, or the current responsible local Hearthstone dealer, for instructions regarding the return of defective parts for repair, the return of the appliance for repair, or to schedule a Dealer service call. The Original Purchaser should refer to the Dealer Network search engine contained on Hearthstone's Web site (www.hearthstonestoves.com) if the original dealer is not available, to find a Hearthstone dealer nearest to the Original Purchaser's location.

REMEDY

The remedy for any breach of the foregoing warranties will consist of repair or replacement, at Hearthstone's option, of any covered defect in the appliance. When the Original Purchaser contacts a Hearthstone Dealer, the Dealer on behalf of Hearthstone, as the case may be, will instruct the Original Purchaser to either return the defective part, or the entire appliance (if requested), to the Dealer or Hearthstone or allow a Dealer to make a service call at the place where the appliance is located. Hearthstone may require that a digital picture be provided to support the claim. Notwithstanding any other provision of this document, the Original Purchaser shall pay for any fees and service charges related to a Dealer's service call or the shipping charges associated with the return.

WARRANTY REGISTRATION

The Original Purchaser can complete their warranty registration on our website at www.hearthstonestoves.com. Hearthstone's physical address is:

Hearthstone Quality Home Heating Products, Inc.
Warranty Department
317 Stafford Avenue
Morrisville, VT 05661

NOTE: ON-LINE REGISTRATION IS *NOT REQUIRED* AS A CONDITION OF WARRANTY COVERAGE OR HEARTHSTONE'S PERFORMANCE.